

# CYBERGUN

AIRSOFT & AIRGUN COLLECTION

---

 CYBERGUN



**WELCOME**  
BIENVENUE - BIENVENIDO

## COLLECTION 2024

CYBERGUN is proud to present the new edition of its annual catalog.

You will find a large selection of new products dedicated to airsoft and airgun but also a large part of our permanent line catalog.

FN Herstal, Colt, CANiK, Kalashnikov, PGM Precision, Thompson, so many licenses that are renewed this year for the pleasure of our partners.

As usual, you will find licensed products, which followed a thorough process of development and approval by the best firearms licensors.

The entire CYBERGUN team remains at your disposal to answer all your questions, and thanks you for your trust.

**Hugo BRUGIERE**  
Chairman & CEO



Your sales team - Votre équipe commerciale - Su equipo comercial







> Automatic Electric Gun  
 EN: The replica is battery powered.  
 FR: La réplique utilise une batterie pour tirer.  
 ES: La réplica usa una batería para disparar.



EN: The replica uses a magazine filled with propane gas.  
 FR: La réplique utilise un chargeur rempli de gaz propane.  
 ES: La réplica usa un cargador lleno de gas propano.



EN: Some parts of the replica are made with real wood adding more realism.  
 FR: Certaines parties de la réplique sont en bois véritable pour plus de réalisme.  
 ES: Alguna parte de la réplica está realizada con madera auténtica añadiendo más realismo.



EN: For handguns replicas, only the slide is metal.  
 FR: Pour les répliques de poing, seule la culasse est métallique.  
 ES: Para las réplicas de pistolas, sólo la culata es metálica.



EN: Some replicas have a metallic upper body.  
 FR: Certaines répliques peuvent avoir la partie supérieure du corps en métal.  
 ES: Algunas réplicas pueden tener la parte superior del cuerpo de metal.



EN: Gears inside the gearbox are entirely made from metal.  
 FR: Les engrenages à l'intérieur de la gearbox sont en métal.  
 ES: Los engranajes dentro la gearbox están completamente hechos de metal.



EN: Hop-Up system gives to every shots fired a better range and accuracy. Depending on how it is adjusted, performances may vary significantly.  
 FR: Le système Hop-Up augmente la portée et la précision de chaque tir. Selon le réglage, les performances de la réplique peuvent varier.  
 ES: El sistema Hop-Up aumenta el alcance y la precisión de cada disparo. Dependiendo de la configuración, el rendimiento de la réplica puede variar.



EN: A non-blowback replica is a pistol with fixed slide when shooting.  
 FR: Une réplique non-blowback est une réplique dont la culasse est fixe lors du tir.  
 ES: Una réplica non-blowback es una réplica con culata fija al disparar.



EN: Quick access to the spring compression adjustment screw to change the velocity of the replica.  
 FR: Accès rapide à une vis de réglage de compression du ressort pour faire varier la puissance de la réplique.  
 ES: Acceso rápido a un tornillo de ajuste de la compresión del muelle para variar la potencia de la réplica.



> Automatic Electric Pistol  
 EN: The pistol replica uses a battery to shoot.  
 FR: La réplique de poing utilise une batterie pour tirer.  
 ES: La réplica de pistola usa una batería para disparar.



EN: A quick change spring system to vary the velocity of the replica.  
 FR: Un système de changement rapide du ressort pour faire varier la puissance de la réplique.  
 ES: Un sistema de cambio de resorte rápido para variar la velocidad de la réplica.



EN: The replica must be manually cocked with a spring to shoot.  
 FR: La réplique doit être armée manuellement avec un ressort pour tirer.  
 ES: La réplica debe ser amartillada manualmente con un resorte para disparar.



EN: The replica uses a CO<sub>2</sub> cartridge to insert into the magazine to shoot.  
 FR: La réplique utilise une cartouche CO<sub>2</sub> à insérer dans le chargeur pour tirer.  
 ES: La réplica usa un cartucho de CO<sub>2</sub> que se introduce en el cargador para disparar.



EN: The replica has the same metal parts as the original model.  
 FR: Comme le véritable modèle, la réplique dispose des mêmes parties métalliques.  
 ES: Al igual que el modelo real, la réplica tiene las mismas piezas metálicas.



EN: A polymer with a high impact resistance giving the replica lightness and robustness.  
 FR: Un polymère ayant une forte résistance aux chocs donnant à la réplique légèreté et robustesse.  
 ES: Un polímero de gran resistencia al impacto que confiere a la réplica ligereza y robustez.



EN: A plastic which gives the replica a light and resistant body.  
 FR: Un plastique qui donne à la réplique un corps léger et résistant.  
 ES: Un plástico que da a la réplica un cuerpo ligero y resistente.



EN: The replica external body is made of metal.  
 FR: Tout le corps de la réplique est métallique.  
 ES: Todo el cuerpo de la réplica está hecho de metal.



EN: BAX system is Cybergun's very own alternative to the Hop-Up system. Depending on how it is adjusted, performances may vary significantly.  
 FR: Le système BAX est l'alternative brevetée par Cybergun au système Hop-Up. Selon le réglage, les performances de la réplique peuvent varier.  
 ES: El sistema BAX es la alternativa propia de Cybergun al sistema Hop-Up. Dependiendo de cómo se ajuste, las prestaciones pueden variar significativamente.



EN: A blowback replica has its slide or bolt moving at each shots giving more realism of the mechanism.  
 FR: Une réplique blowback dispose d'une culasse mobile qui recule à chaque tir augmentant le réalisme du mécanisme.  
 ES: Una réplica blowback tiene una culata móvil que se mueve con cada disparo aumentando el realismo del mecanismo.



EN: Electronic module that improves the autonomy and reliability of a replica, and provides protection in case of electrical overload.  
 FR: Module électronique qui améliore l'autonomie et la fiabilité d'une réplique, et assure une protection en cas de surcharge électrique.  
 ES: Módulo electrónico que mejora la autonomía y fiabilidad de una réplica, y proporciona protección en caso de sobrecarga eléctrica.



EN: A additional spring is supplied with the replica.  
 FR: Un ressort supplémentaire est fourni avec la réplique.  
 ES: Un muelle adicional es suministrado con la réplica.



EN: Electronic system that increases the reactivity of the replica.  
 FR: Système électronique qui augmente la réactivité de la réplique.  
 ES: Sistema electrónico que aumenta la reactividad de la réplica.



# NEW PRODUCTS

NOUVEAUTÉS - NOVEDADES

8  
10  
14  
15  
16  
19  
23  
24



NEW+

CANiK  
SUPERIOR FIREARMS



**CANiK SFX RIVAL**  
550008 (BLACK) / 550009 (DUAL TONE) / 550010 (GREY)



NEW+

CANiK  
SUPERIOR FIREARMS



550007 (TAN) / 550015 (BLACK) / 550016 (DUAL TONE)

**CANiK TP9 ELITE COMBAT**  
**INOXATSU**

WITH THE OFFICIAL CANiK CASE, KYDEX HOLSTER, RMR PLATES, BACKSTRAP, METAL AUTHENTICITY CARD AND PATCH.

NEW+



NEW+

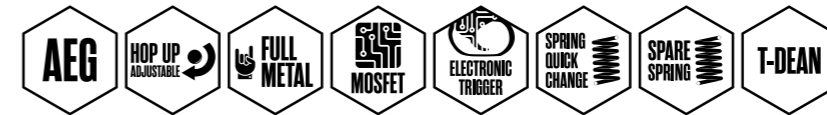
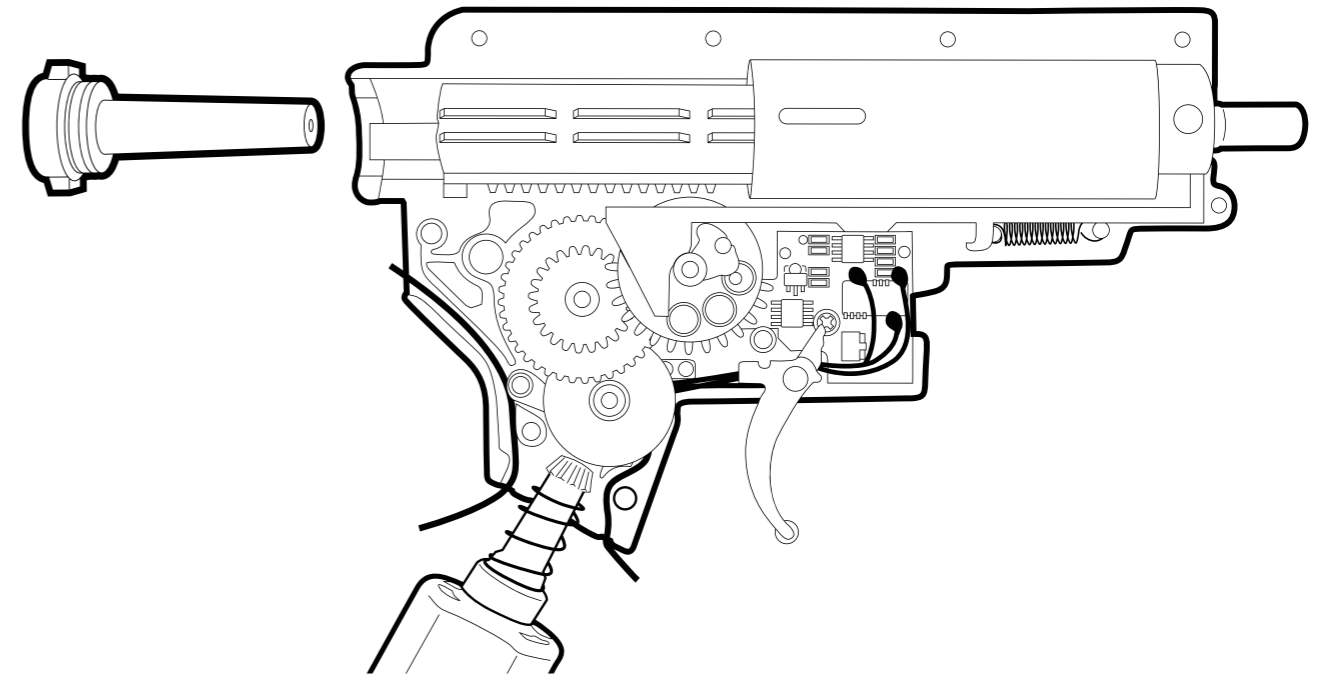

180220 (FDE) / 180221 (BLACK) / 180036 (GREY) / 180037 (GREEN) / 180038 (PURPLE)

# COLT M4 HORNET

## Reinforced Gearbox / Gearbox renforcée / Gearbox reforzada :

- **Ø6.02 mm steel inner barrel** / Canon interne Ø6.02 mm en acier / Barril interno Ø6.02 mm en acero
- **Aluminum CNC Hop-Up Unit** / Bloc Hop-Up Aluminium CNC / Bloc Hop-Up Aluminium CNC
- **Air Nozzle with O-ring** / Nozzle avec joint torique / Boquilla de aire con junta tórica
- **CNC V2 cylinder head** / Tête de cylindre V2 CNC / Cabeza de cilindro V2 CNC
- **Stainless steel cylinder** / Cylindre en acier inoxydable / Cilindro de acero inoxidable
- **High Torque motor long axel** / Moteur High Torque Axe Long / Motor de alto par eje largo
- **13:1 ratio CNC gears** / Engrenages acier CNC 13:1 / Engranajes acero CNC 13:1
- **Delayer** / Sector Clip / Retardador
- **M100 Spring** / Ressort M100 / Resorte M100
- **QD spring guide with bearing** / Guide ressort QD sur roulement / Resorte guía QD sobre cojinete
- **14 steel Teeth Piston** / Piston 14 Dents Acier / Pistón 14 Dientes Acero
- **Double O-ring aluminum Piston Head with bearing** / Tête de Piston aluminium sur roulement avec double joint torique / Cabeza de Pistón aluminio sobre cojinete con doble junta tórica

**Electronic trigger with Mosfet** / Détente électronique avec Mosfet / Gatillo electrónico con Mosfet  
**T-DEAN Plug** / Cosse T-DEAN / Cableado en T-DEAN

NEW+



**COLT M4 CHARLIE**  
180271 (BLACK) / 180272 (DUAL TONE)



**COLT M4 DELTA**  
180273



**COLT M4 ECHO**  
180278 (BLACK) / 180279 (DUAL TONE)

NEW+



**COLT M16A1**  
180444



**COLT XM177E2**  
180447



NEW+

# FAMAS



## FAMAS F1

400912 (1 J) / 400913 (1.3 J) / 400914 (1.6 J - SEMI ONLY)



EXCLUSIVE PARTNERSHIP - PARTENARIAT EXCLUSIF - ASOCIACIÓN EXCLUSIVA

TANFOGLIO

NEW+



## TANFOGLIO GOLD CUSTOM

350512 (GEN2)



## TANFOGLIO LIMITED CUSTOM

350513 (GEN2)



NEW+



  **FN 509® COMPACT MRD**  
200112 (BLACK) / 200135 (FDE) / 200143 (DUAL TONE)



  **FN 509® COMPACT TACTICAL**  
200145 (BLACK) / 200110 (FDE)

NEW+



    **FN 509® CIVILIAN**  
200563 (BLACK) / 200566 (FDE) / 200567 (DUAL TONE)



    **FN 509® TACTICAL**  
200569 (BLACK) / 200568 (FDE)

NEW+



    **FN MINIMI® M249 PARA**  
200023

NEW+



    **FN® FNC**  
200024



    **FN® FAL**  
200021



    **CENTURY ARMS C96**  
570000 (1.2 J) / 570002 (1.7 J)

NEW+



**CENTURY ARMS MAKAROV**  
570001



**CENTURY ARMS TOKAREV TT33**  
570004

NEW+



**CENTURY ARMS WASR-10**  
570005



**CENTURY ARMS WASR-10UF**  
570008

NEW+



### CENTURY ARMS MOSIN M91/30

570007



### CENTURY ARMS KAR98

570006

NEW+



### SWISS ARMS MILE

280055 (BLACK) / 280056 (FDE) / 280057 (DUAL TONE)



### SWISS ARMS PROTECTOR

280583 (BLACK) / 280584 (TAN)

THE TRADE DRESS OF THESE PRODUCTS IS OWNED BY SIG SAUER, INC., USED UNDER LICENSE.



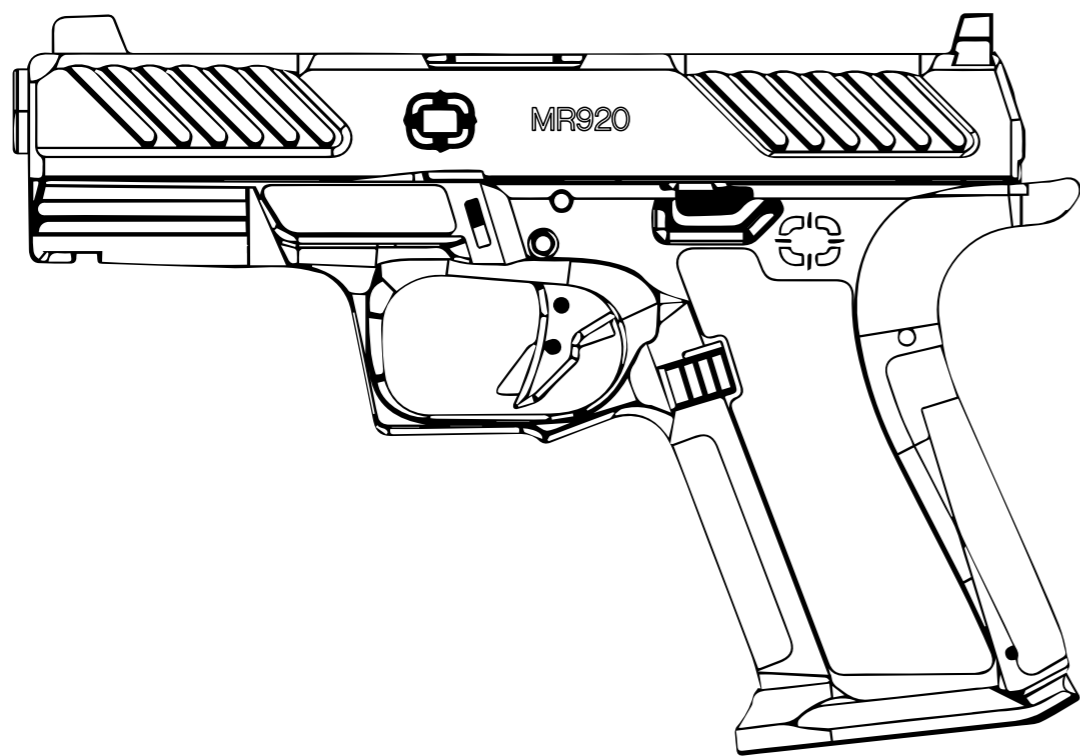

**SHADOW SYSTEMS MR920**  
MR920

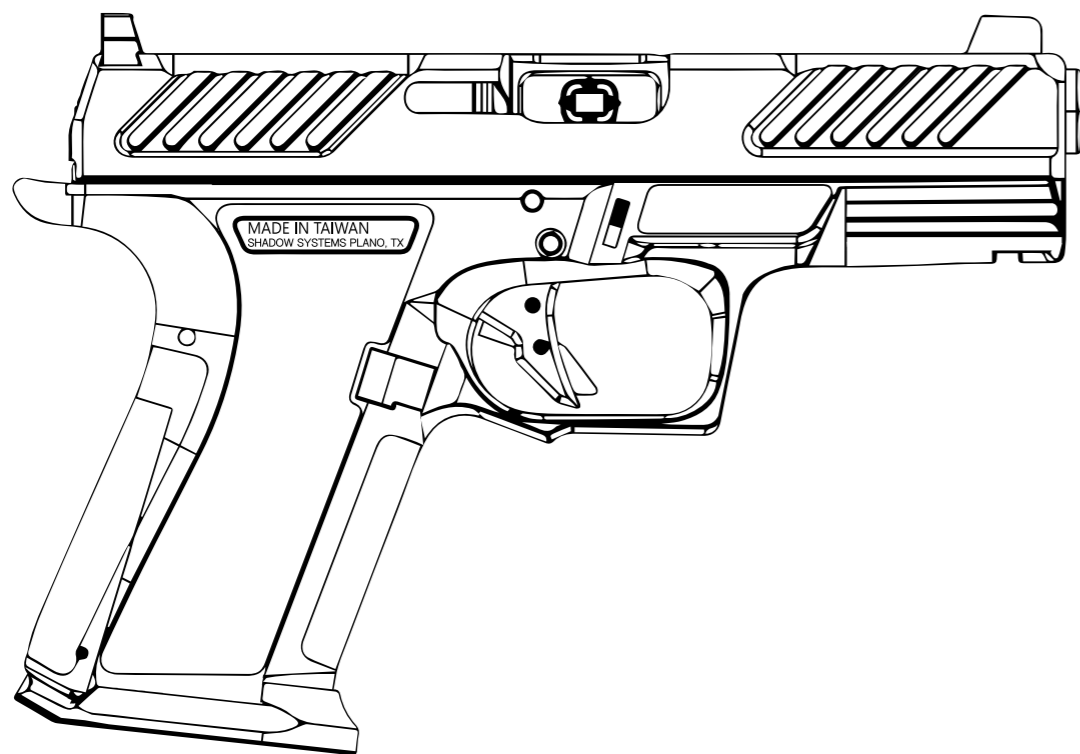

ITEM	POWER	FPS - m/s	ENERGY	MAG. CAPACITY	WEIGHT	LENGTH	POWER RANGE
550008/09/10	GAS	310 FPS - 95 m/s	0.9 J	22 BBs	835 g	21 cm	35 m
550007/15/16	CO <sub>2</sub>	330 FPS - 100 m/s	1 J	22 BBs	692 g	20 cm	35 m
180220/21	AEG	330 FPS - 100 m/s	1 J	90 BBs	3330 g	80-87 cm	40 m
180036/37/38	AEG	330 FPS - 100 m/s	1 J	90 BBs	3330 g	80-87 cm	40 m
180271/72	AEG	330 FPS - 100 m/s	1 J	120 BBs	2200 g	65-74 cm	40 m
180273	AEG	330 FPS - 100 m/s	1 J	120 BBs	2200 g	67-76 cm	40 m
180278/79	AEG	330 FPS - 100 m/s	1 J	120 BBs	2200 g	69-77 cm	40 m
180444	AEG	415 FPS - 130 m/s	1.6 J	190 BBs	2600 g	98 cm	45 m
180447	AEG	415 FPS - 130 m/s	1.6 J	190 BBs	2500 g	82 cm	45 m
400912	GAS	415 FPS - 130 m/s	1.6 J	25 BBs	4200 g	76 cm	45 m
350512/13	CO <sub>2</sub>	330 FPS - 100 m/s	1 J	18 BBs	1400 g	22 cm	35 m
200112/135/143	SPRING	150 FPS - 45 m/s	0.2 J	90 BBs	156 g	17 cm	15 m
200110/45	SPRING	150 FPS - 45 m/s	0.2 J	90 BBs	156 g	17 cm	15 m
200563/66/67	CO <sub>2</sub>	330 FPS - 100 m/s	1 J	21 BBs	776 g	19 cm	35 m
200564	GAS	330 FPS - 100 m/s	1 J	21 BBs	776 g	19 cm	35 m
200023	GAS	330 FPS - 100 m/s	1 J	175 BBs	3640 g	91 cm	40 m
200021	GAS	415 FPS - 130 m/s	1.6 J	25 BBs	3850 g	109 cm	45 m
200024	GAS	330 FPS - 100 m/s	1 J	30 BBs	4100 g	100 cm	40 m
570000	CO <sub>2</sub>	360 FPS - 110 m/s	1.2 J	22 BBs	1400 g	30 cm	35 m
570001	CO <sub>2</sub>	370 FPS - 113 m/s	1.3 J	15 BBs	740 g	16 cm	35 m
570002	CO <sub>2</sub>	427 FPS - 130 m/s	1.7 J	22 BBs	1400 g	30 cm	40 m
570004	GAS	310 FPS - 92 m/s	0.9 J	15 BBs	670 g	19 cm	35 m
570005	AEG	360 FPS - 110 m/s	1.2 J	140 BBs	3550 g	90 cm	40 m
570006	SPRING	390 FPS - 119 m/s	1.4 J	25 BBs	3270 g	109 cm	45 m
570007	SPRING	390 FPS - 119 m/s	1.4 J	35 BBs	3450 g	123 cm	45 m
570008	AEG	360 FPS - 110 m/s	1.2 J	140 BBs	3400 g	86 cm	40 m
280055/56/57	GAS	330 FPS - 100 m/s	1 J	21 BBs	766 g	19 cm	35 m
280583/84	CO <sub>2</sub>	330 FPS - 100 m/s	1 J	25 BBs	2177 g	60 cm	35 m
MR920	GAS	330 FPS - 100 m/s	1 J	15 BBs	580 g	18 cm	35 m

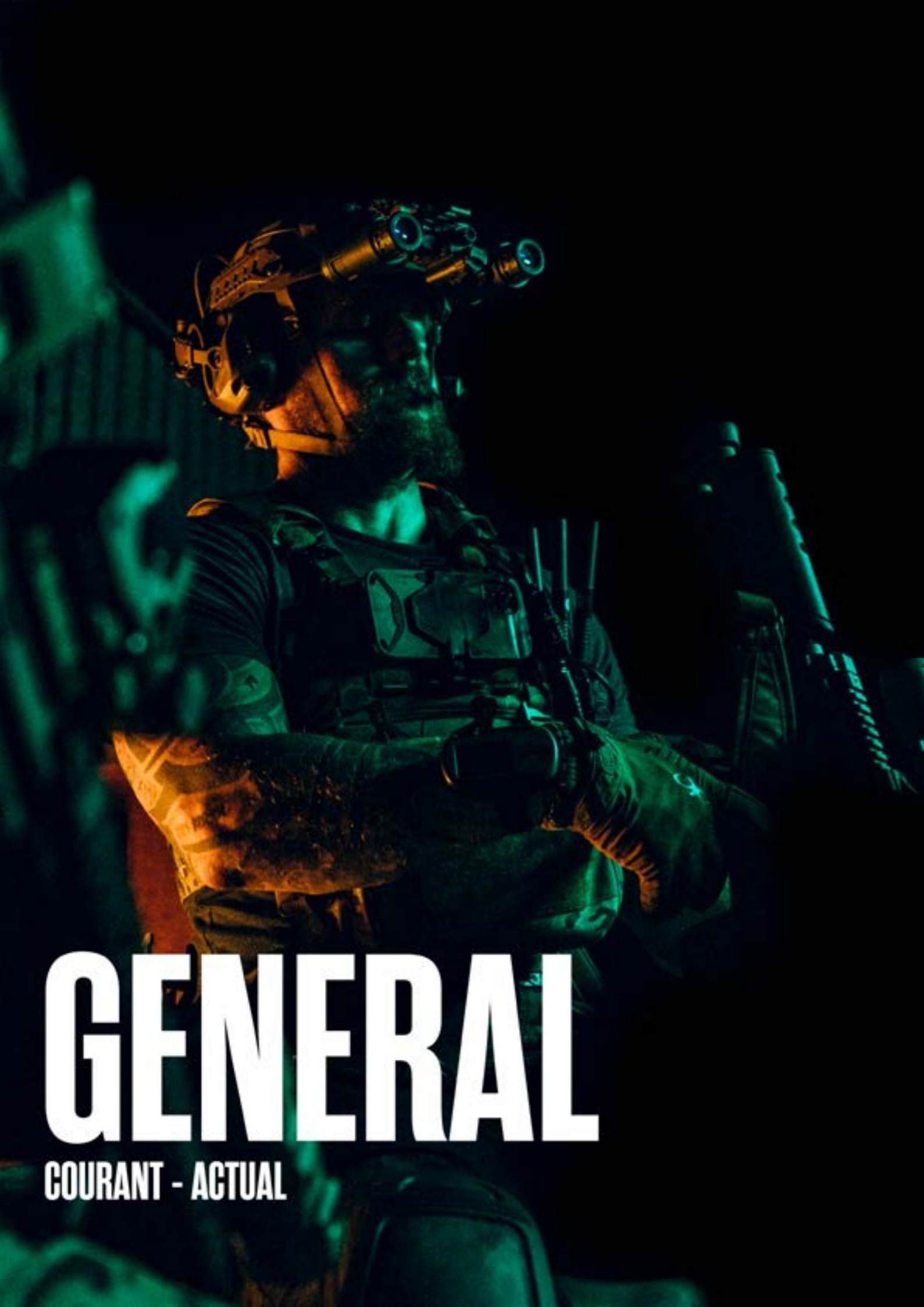

# GENERAL

COURANT - ACTUAL

28  
30  
44  
48  
56  
58  
78  
86  
88  
90  
92  
94  
98  
100  
104  
110  
112





**CANiK TP9 ELITE COMBAT**  
550001



603511  
603512  
+ 555000



**CANiK TP9 ELITE COMBAT**  
550002



603511  
603512  
+ 555000



**CANiK TP9 ELITE COMBAT**  
550003



603511  
603512  
+ 555000



**RMR MOUNTS FOR TP9 ELITE COMBAT**  
553010 (BLACK) / 553011 (TAN)



CANiK is a Turkish company created in 1998 and specialized in handguns designed for Sport shooting and Defense. CANiK pistols - famous for their reliability and ergonomics - are used by the Turkish armed forces as well as sports shooters worldwide.

CANiK's most famous manufactured products are the TP9 series, polymer-framed semi-automatic pistols, thanks to the quality of their corrosion-resistant components ensuring excellent durability.

Entreprise turque créée en 1998, CANiK est spécialisé dans les armes de poing destinées au tir sportif et à la défense. Ses pistolets, réputés pour leur fiabilité et leur ergonomie, sont utilisés par les forces armées Turques ainsi que les tireurs sportifs à l'international.

Reconnue pour sa série de pistolets semi-automatiques TP9 à carcasse en polymère, CANiK assure grâce à des composants internes de qualité une excellente durabilité de ses produits et une haute résistance à la corrosion.

ITEM	POWER	FPS - m/s	ENERGY	MAG. CAPACITY	WEIGHT	LENGTH	POWER RANGE
550001 550002 550003	GAS	330 FPS - 100 m/s	1 J	22 BBs	850 g	20 cm	35 m



In 1832 at the early age of 18, Samuel Colt designed a revolutionary mechanism that changed the course of firearms history : the revolver, which became the perfect combination of pepperbox guns and revolving flintlock guns. His handgun was more reliable and faster than any other ones back then, and quickly overshadowed all previous firearm mechanisms.

In 1836 Samuel Colt patented the Colt Paterson, very first of a long series of successful revolvers such as the Colts Walker, the 1848 Dragoon, the 1851 Navy, the 1860 Army and last but not least the legendary 1873 Single Action Army known as "The Peacemaker".

Colt Firearms Company kept innovating long after its founder's death in 1862, and always brings satisfaction to Police and Law Enforcements, to Military Enforcements, and even to civilians all around the world thanks to famous firearms such as the Colt 1911, the Colt Python or even the cult M16 Assault Rifle and its derivatives.

En 1832 à l'âge de 18 ans seulement, Samuel Colt conçoit un mécanisme qui révolutionnera les armes à feu : le revolver. La synthèse parfaite entre les poivrières, les pistolets et fusils à platine, à silex avec barillet, seules armes utilisées jusqu'alors. Son arme est plus fiable et plus rapide que toutes celles alors en usage, et éclipse les autres mécaniques en quelques décennies.

En 1836, Samuel Colt brevète le Colt Paterson, le premier d'une longue série de revolvers à succès : le Colt Walker, le Colt Model 1848 « Dragoon », le Colt Model 1851 « Navy », le model 1860 « Army », et l'incontournable Model 1873 Single Action Army, surnommé le « Peacemaker ».

La Colt Firearms Company continua d'innover après la mort de son fondateur en 1862, et accompagne toujours aussi bien les forces armées de par le monde tout autant que les particuliers, avec des armes aussi célèbres que l'indémodable Colt 1911, le Colt Python ou le cultissime fusil d'assaut M16 et ses dérivés.



**COLT M4 HORNET BLACK FOX**  
180767



⚡ 639061  
639063  
+ 185171  
185172



**COLT M4 SIERRA**  
180024 (BLACK) / 180025 (BLUE) / 180026 (RED)



⚡ 639058  
639059  
639061  
+ 185172



**COLT M4 HORNET**  
180768 (RED FOX) / 180770 (BLUE FOX)



⚡ 639061  
639063  
+ 185171  
185172



**COLT M4 MIKE**  
180028 (BLACK) / 180029 (BLUE) / 180030 (RED)



⚡ 639058  
639059  
639061  
+ 185172



**COLT M4 BLAST**  
180769 (RED FOX) / 180771 (BLUE FOX)



⚡ 639061  
639063  
+ 185171  
185172



**COLT M4 LIMA**  
180032 (BLACK) / 180033 (BLUE) / 180034 (RED)

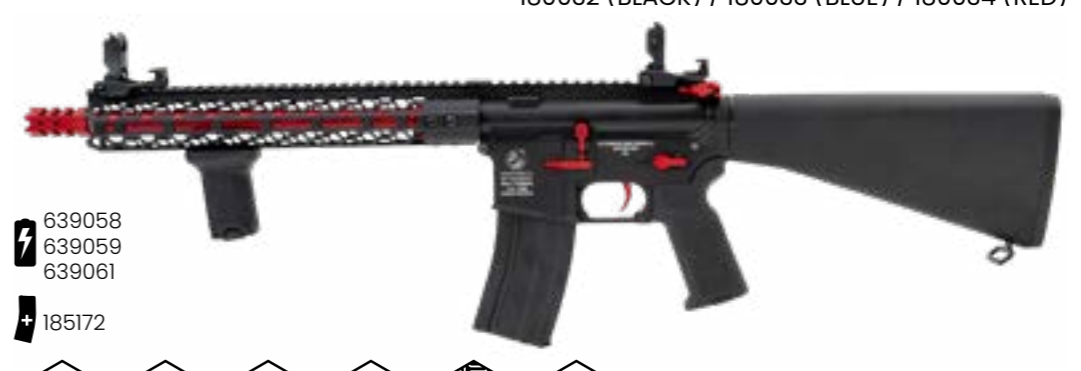

⚡ 639058  
639059  
639061  
+ 185172

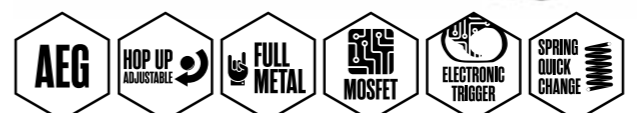

**COLT M4 HAWKEYE**  
180766

**COLT M4 AIRLINE MOD A**  
180856 (BLACK) / 180857 (TAN)



⚡ 639061  
639063  
+ 185171  
185172

⚡ 639061  
639063  
+ 185171  
185172

**COLT M4A1 CARBINE**  
180860 (NYLON FIBER) / 180865 (FULL METAL)

**COLT M4 SPECIAL FORCES MINI**  
180866 (BLACK) / 180867 (TAN) / 180862 (BLACK: NYLON FIBER)



⚡ 639061  
639063  
+ 185171  
185172

⚡ 639061  
639063  
+ 185171  
185172

**COLT M4A1 RIS**  
180559

**COLT M4 SILENT OPS**  
180870 (BLACK) / 180871 (TAN) - 180863 (BLACK) / 180864 (TAN) (NYLON FIBER)



✓ 603513  
603514  
+ 185163

⚡ 639061  
639063  
+ 185171  
185172

**COLT M4 SPECIAL FORCES**  
180861



⚡ 639061  
639063  
+ 185171  
185172



**COLT M4 AIRLINE MOD B**  
180858



⚡ 639061  
639063  
+ 185171  
185172



**COLT M4 HARVEST**  
180859



⚡ 639061  
639063  
+ 185171  
185172



ITEM	POWER	FPS - m/s	ENERGY	MAG. CAPACITY	WEIGHT	LENGTH	POWER RANGE
<b>180767</b>	AEG	330 FPS - 100 m/s	1 J	300 BBs	3330 g	87 cm	50 m
<b>180768</b> <b>180770</b>	AEG	330 FPS - 100 m/s	1 J	300 BBs	3350 g	73 cm	50 m
<b>180769</b> <b>180771</b>	AEG	330 FPS - 100 m/s	1 J	300 BBs	3565 g	88 cm	50 m
<b>180024</b> <b>180025</b> <b>180026</b>	AEG	330 FPS - 100 m/s	1 J	90 BBs	3300 g	70-80 cm	50 m
<b>180028</b> <b>180029</b> <b>180030</b>	AEG	330 FPS - 100 m/s	1 J	90 BBs	3400 g	80-90 cm	50 m
<b>180032</b> <b>180033</b> <b>180034</b>	AEG	330 FPS - 100 m/s	1 J	90 BBs	3500 g	90 cm	50 m
<b>180766</b>	AEG	330 FPS - 100 m/s	1 J	300 BBs	3565 g	88 cm	50 m
<b>180861</b>	AEG	330 FPS - 100 m/s	1 J	300 BBs	3330 g	87 cm	50 m
<b>180866</b> <b>180867</b>	AEG	330 FPS - 100 m/s	1 J	300 BBs	3220 g	73 cm	50 m
<b>180870</b> <b>180871</b>	AEG	330 FPS - 100 m/s	1 J	300 BBs	3375 g	81 cm	50 m
<b>180856</b> <b>180857</b>	AEG	330 FPS - 100 m/s	1 J	300 BBs	3565 g	88 cm	50 m
<b>180858</b>	AEG	330 FPS - 100 m/s	1 J	300 BBs	3565 g	88 cm	50 m
<b>180859</b>	AEG	330 FPS - 100 m/s	1 J	300 BBs	3565 g	88 cm	50 m
<b>180860</b> <b>180865</b>	AEG	330 FPS - 100 m/s	1 J	300 BBs	2269 g	89 cm	50 m
<b>180559</b>	GAS	393 FPS - 120 m/s	1.5 J	35 BBs	2750 g	86 cm	60 m



**COLT 1911 RAIL GUN®**  
180314



633505  
633510  
+ 285052

CO<sub>2</sub> NBB METAL SLIDE

**COLT 1911 RAIL GUN®**  
180315



633505  
633510  
+ 285052

CO<sub>2</sub> NBB METAL SLIDE

**COLT 1911 COMBAT UNIT**  
180564



633505  
633510  
+ 185150  
185160

CO<sub>2</sub> BAX ADJUSTABLE BLOW BACK FULL METAL

**COLT M45A1**  
180521



633505  
633510  
+ 185150  
185160

CO<sub>2</sub> BAX ADJUSTABLE BLOW BACK FULL METAL

**COLT 1911 RAIL GUN®**  
180524



633505  
633510  
+ 185150  
185160

CO<sub>2</sub> BAX ADJUSTABLE BLOW BACK FULL METAL

**COLT 1911 RAIL GUN®**  
180525



633505  
633510  
+ 185150  
185160

CO<sub>2</sub> BAX ADJUSTABLE BLOW BACK FULL METAL

**COLT M45A1**  
180313



633505  
633510  
+ 285052

CO<sub>2</sub> NBB METAL SLIDE

**COLT M1911 MATCH**  
180306



633505  
633510  
+ 185136

CO<sub>2</sub> NBB ABS

**COLT 1911 RAIL GUN®**  
180530



633505  
633510  
+ 185150  
185160

CO<sub>2</sub> BAX ADJUSTABLE BLOW BACK FULL METAL

**COLT 1911 RAIL GUN®**  
180531



633505  
633510  
+ 185150  
185160

CO<sub>2</sub> BAX ADJUSTABLE BLOW BACK FULL METAL

ITEM	POWER	FPS - m/s	ENERGY	MAG. CAPACITY	WEIGHT	LENGTH	POWER RANGE
180313 180314 180315	CO <sub>2</sub>	328 FPS - 100 m/s	1 J	15 BBs	830 g	21,9 cm	25 m
180524 180525 180530 180531 180564 180521	CO <sub>2</sub>	328 FPS - 100 m/s	1 J*	17 BBs	976 g	22 cm	35 m
180306	CO <sub>2</sub>	328 FPS - 100 m/s	1 J	13 BBs	600 g	21,9 cm	30 m

\*CONVERSION KIT 1.4 J: 183197



**COLT MK IV SERIES 70**  
180529



633505  
633510  
185150  
185160

CO<sub>2</sub> BAX ADJUSTABLE BLOW BACK FULL METAL

**COLT M1911A1**  
180512



633505  
633510  
185150  
185160

CO<sub>2</sub> BAX ADJUSTABLE BLOW BACK FULL METAL

**COLT M1911A1**  
180123



SPRING BAX FIXE ABS

**COLT M1911A1**  
180116 (BLACK) / 180126 (TAN)



180131 180132  
185011

SLIDE BODY SLIDE BODY SPRING BAX FIXE METAL SLIDE

**COLT 1911 PARKERIZED**  
180532



633505  
633510  
185150  
185160

CO<sub>2</sub> BAX ADJUSTABLE BLOW BACK FULL METAL

**COLT 1911**  
180567 (BLACK) / 180568 (SILVER)



633505  
633510  
603511  
603512  
185173 - CO<sub>2</sub>  
185174 - GAS

CO<sub>2</sub> HOP UP ADJUSTABLE BLOW BACK FULL METAL

**COLT PYTHON .357 4"**  
180310



633505  
633510  
185144

CO<sub>2</sub> BAX ADJUSTABLE FULL METAL

**COLT JUNIOR**  
180592 (BLACK) / 180593 (SILVER)



603511  
603512  
185176

GREEN GAS HOP UP ADJUSTABLE BLOW BACK FULL METAL

**COLT 1911**  
180772



185182

AEP HOP UP ADJUSTABLE NBB METAL SLIDE

**COLT 1911**  
180773



185182

AEP HOP UP ADJUSTABLE NBB METAL SLIDE MOSFET

ITEM	POWER	FPS - m/s	ENERGY	MAG. CAPACITY	WEIGHT	LENGTH	POWER RANGE
180529	CO <sub>2</sub>	328 FPS - 100 m/s	1 J*	17 BBs	885 g	21,7 cm	30 m
180512 180532	CO <sub>2</sub>	328 FPS - 100 m/s	1 J*	17 BBs	976 g	22 cm	30 m
180567 180568	CO <sub>2</sub>	328 FPS - 100 m/s	1 J	15 BBs	976 g	22 cm	40 m
180772 180773	AEP	207 FPS - 63 m/s	0.4 J	30 BBs	787 g	24 cm	15 m
180123	SPRING	180 FPS - 55 m/s	0.3 J	90 BBs	193 g	21,7 cm	15 m
180116	SPRING	256 FPS - 78 m/s	0.6 J	12 BBs	539 g	21,6 cm	20 m
180126 180131 180132	SPRING	267 FPS - 81 m/s	0.7 J	12 BBs	451 g	21,7 cm	30 m
180310	CO <sub>2</sub>	452 FPS - 137 m/s	1.9 J	6 BBs	1040 g	24 cm	60 m
180592 180593	GAS	215 FPS - 65 m/s	0.43 J	7 BBs	350 g	11 cm	15 m

\*CONVERSION KIT 1.4 J: 183197

**COLT 1911 PORTED**  
180139 (SILVER) / 180164 (DE SLIDE) / 180165 (SILVER SLIDE)



603511  
603512  
185189  
185190

GREEN GAS HOP UP ADJUSTABLE BLOW BACK METAL SLIDE

**COLT 1911 COMBAT**  
180138 (SILVER SLIDE) / 180163 (DE SLIDE)



603511  
603512  
185189  
185190

GREEN GAS HOP UP ADJUSTABLE BLOW BACK METAL SLIDE

**COLT PYTHON .357 6"**  
180391



603511  
603512

GREEN GAS HOP UP FIXED FULL METAL

**COLT PYTHON .357 HUNTER 6"**  
GAS: 180394 (BLACK) / 180398 (SILVER)  
CO<sub>2</sub>: 180419 (BLACK) / 180420 (SILVER)



603511  
603512

GREEN GAS HOP UP FIXED FULL METAL

**COLT 1911 DEFENDER**  
180140 (SILVER SLIDE) / 180141 (BLACK)  
180142 (SILVER) / 180166 (DUAL TONE)



603511  
603512  
185191

GREEN GAS HOP UP ADJUSTABLE BLOW BACK METAL SLIDE

**COLT 1911**  
180143 (BLACK) / 180144 (SILVER)



633505  
633510  
185188

CO<sub>2</sub> HOP UP ADJUSTABLE BLOW BACK METAL SLIDE

**COLT 2009 RAIL CONCEPT**  
180570 (GAS) / 180571 (CO<sub>2</sub>)



603511  
603512  
633505  
633510  
185193 - GAS  
185194 - CO<sub>2</sub>

HOP UP ADJUSTABLE BLOW BACK GREEN GAS FULL METAL

**COLT SAA PEACEMAKER**  
4" VERSION: 180402 (BLACK) / 180384 (SILVER)  
6" VERSION: 180403 (BLACK) / 180387 (SILVER)



603511  
603512  
183304

GREEN GAS FULL METAL

ITEM	POWER	FPS - m/s	ENERGY	MAG. CAPACITY	WEIGHT	LENGTH	POWER RANGE
180139 180164 180165	GAS	310 FPS - 95 m/s	0.9 J	15 BBs	800 g	22 cm	30 m
180138 180163	GAS	310 FPS - 95 m/s	0.9 J	15 BBs	770 g	22 cm	30 m
180140 180141 180142 180166	GAS	310 FPS - 95 m/s	0.9 J	15 BBs	830 g	18 cm	30 m
180143 180144	CO <sub>2</sub>	310 FPS - 95 m/s	0.9 J	15 BBs	850 g	21 cm	30 m
180570	GAS	390 FPS - 120 m/s	1.4 J	28 BBs	1190 g	25 cm	35 cm
180571	CO <sub>2</sub>	390 FPS - 120 m/s	1.4 J	28 BBs	1190 g	25 cm	35 cm
180384 180402	GAS	280 FPS - 85 m/s	0.8 J	6 BBs	836 g	25,3 cm	20 m
180387 180403	GAS	300 FPS - 90 m/s	0.9 J	6 BBs	873 g	30,6 cm	20 m
180391	GAS	260 FPS - 80 m/s	0.6 J	6 BBs	1200 g	29,2 cm	20 m
180394 180398	GAS	260 FPS - 80 m/s	0.6 J	6 BBs	1200 g	29,2 cm	20 m
180419 180420	CO <sub>2</sub>	328 FPS - 100 m/s	1 J	6 BBs	1200 g	29,2 cm	20 m





CYBERGUN



Worldwide leader in softair replica under license for entertainment and professional training, CYBERGUN has been developing for more than 30 years innovative systems that allow it to become a major player in the airsoft and airgun business.

With a global presence on all continents, the French company has made its exclusive and global license book of the largest weapons manufacturers its strike force on every continent.

Leader mondial de la réplique d'arme sous licence pour la pratique de l'Airsoft mais également pour l'entraînement des forces armées, CYBERGUN développe depuis plus de 30 ans des systèmes innovants qui en font un acteur incontournable de l'Airsoft, de l'Airgun et de la simulation.

Forte de sa présence sur tous les continents, l'entreprise Française a fait de son carnet de licences exclusives et mondiales des plus grands fabricants d'armes sa force de frappe.

# PT92 & PT99



CYBERGUN

**CYBERGUN PT99**  
210508



✓ 633505  
633510  
+ 215018

**SPORTIVE**



**CYBERGUN PT99**  
210532



✓ 633505  
633510  
+ 215018



**CYBERGUN PT92 AIRLINE**  
210527



✓ 633505  
633510  
+ 215018

**SPORTIVE**



**CYBERGUN PT92**  
210307



✓ 633505  
633510  
+ 215035

**SPORTIVE**



**CYBERGUN PT92**  
210308



✓ 633505  
633510  
+ 215035

**SPORTIVE**



**CYBERGUN PT92**  
210309



✓ 633505  
633510  
+ 215035





CYBERGUN PT92  
210310



633505  
633510  
+ 215035



CYBERGUN PT92  
210113



CYBERGUN PT24/7 G2  
210520

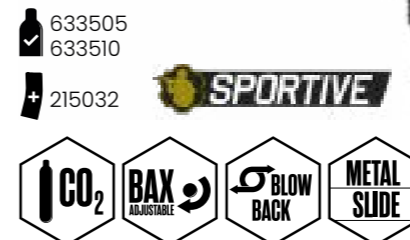

CYBERGUN PT24/7 G2  
210529



CYBERGUN PT92  
210117

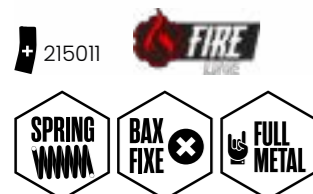

CYBERGUN PT92  
210002



CYBERGUN 24/7  
210303

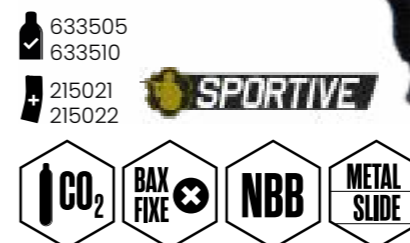

CYBERGUN 24/7  
210119



ITEM	POWER	FPS - m/s	ENERGY	MAG. CAPACITY	WEIGHT	LENGTH	POWER RANGE
210508	CO <sub>2</sub>	295 FPS - 90 m/s	1 J	27 BBs	1140 g	22 cm	35 m
210532	CO <sub>2</sub>	295 FPS - 90 m/s	1 J	27 BBs	1140 g	22 cm	35 m
210527	CO <sub>2</sub>	344 FPS - 105 m/s	1.1 J	27 BBs	1083 g	22 cm	35 m
210307 210308	CO <sub>2</sub>	344 FPS - 105 m/s	1.1 J	13 BBs	970 g 470 g	21,5 cm	20 m
210309 210310	CO <sub>2</sub>	344 FPS - 105 m/s	1.1 J	13 BBs	470 g	21,5 cm	20 m
210113 210117	SPRING	256 FPS - 78 m/s	0.6 J	12 BBs	556 g	21,4 cm	30 m
210002	SPRING	256 FPS - 78 m/s	0.6 J	12 BBs	230 g	21,4 cm	15 m

ITEM	POWER	FPS - m/s	ENERGY	MAG. CAPACITY	WEIGHT	LENGTH	POWER RANGE
210520 210529	CO <sub>2</sub>	295 FPS - 90 m/s	1 J	19 BBs	803 g	18,7 cm	35 m
210303	CO <sub>2</sub>	380 FPS - 116 m/s	1.1 J	13 BBs	580 g	18 cm	20 m
210119	SPRING	232 FPS - 71 m/s	0.5 J	24 BBs	578 g	18 cm	15 m





The Desert Eagle is one of the most emblematic guns, famous for the huge firepower of its diverse calibers, from .357 Magnum to .50AE and .44 Magnum, it is known as the ultimate heavy handgun.

This pistol was designed by Magnum Research Inc. and the Riga Arms Institute between 1979 and 1982. It was first patented in January 1983 in the USA, and then a second time in 1985 after Israel Military Industries (IMI) brought several upgrades. The 1985 model became definitive and this version was finally put into production.

The Desert Eagle became very popular this year, and could be seen in many action movies such as "Commando" by Mark L. Lester, starring Arnold Schwarzenegger in 1985. Since the 90's the Desert Eagle appears in a huge number of video games also, including the Tomb Raider series, GTA, Far Cry, Counter-Strike, etc.

Conçu entre 1979 et 1982 par Magnum Research Inc. et le Riga Arms Institute et réputé pour la grande puissance des munitions qu'il est capable de tirer, du .357 Magnum au .50AE en passant par le .44 Magnum, le Desert Eagle est l'arme de poing "lourde" par excellence.

En Janvier 1983, un brevet fut déposé aux Etats-Unis, puis un second en 1985 après une série d'améliorations apportées par Israel Military Industries (IMI) ; c'est ce second modèle qui entra en production.

Très populaire dès l'année de sa sortie, on le voit apparaître dans plusieurs films d'action, comme le cultissime "Commando" de Mark L. Lester, avec Arnold Schwarzenegger. À partir des années 1990 et jusqu'à aujourd'hui, le Desert Eagle apparaît dans une grande variété de jeux vidéo, tels que les Tomb Raider, GTA, Far Cry ou encore Counter-Strike.

DESERT EAGLE L6 .50 AE  
950509



- 603511
- 603512
- 603513
- 603514

- 095015 - GAS
- 955003 (20 BBs) - CO<sub>2</sub>



DESERT EAGLE L6 .50 AE  
950510



- 603511
- 603512
- 603513
- 603514

- 095015 - GAS
- 955003 (20 BBs) - CO<sub>2</sub>



ITEM	POWER	FPS - m/s	ENERGY	MAG. CAPACITY	WEIGHT	LENGTH	POWER RANGE
950509 950510	GAS	366 FPS - 112 m/s	1.25 J	27 BBs	1300 g	27 cm	35 m

**DESERT EAGLE L6 TIGER STRIPES**  
950522



- 603511
- 603512
- 603513
- 603514
- 095015 - GAS
- 955003 (20 BBs) - CO<sub>2</sub>



**DESERT EAGLE L6 TIGER STRIPES**  
950523



- 603511
- 603512
- 603513
- 603514
- 095015 - GAS
- 955003 (20 BBs) - CO<sub>2</sub>



**DESERT EAGLE L6 .50 AE**  
950501



- 633505
- 633510
- 095011



**DESERT EAGLE L6 .50 AE**  
950503



- 633505
- 633510
- 095011



**DESERT EAGLE L6 TIGER STRIPES**  
950524



- 603511
- 603512
- 603513
- 603514
- 095015 - GAS
- 955003 (20 BBs) - CO<sub>2</sub>



**DESERT EAGLE L6 .50 AE**  
950504



- 633505
- 633510
- 095011



EXCLUSIVE PARTNERSHIP - PARTENARIAT EXCLUSIF - ASOCIACIÓN EXCLUSIVA

ITEM	POWER	FPS - m/s	ENERGY	MAG. CAPACITY	WEIGHT	LENGTH	POWER RANGE
950522 950523 950524	GAS	360 FPS - 110 m/s	1.2 J	27 BBs	1300 g	27 cm	35 m

ITEM	POWER	FPS - m/s	ENERGY	MAG. CAPACITY	WEIGHT	LENGTH	POWER RANGE
950501 950503 950504	CO <sub>2</sub>	328 FPS - 100 m/s	1 J	21 BBs	1200 g	27 cm	35 m



DESERT EAGLE L6 .50 AE  
950501



633505  
633510  
+ 095011



DESERT EAGLE L6 .50 AE  
950503



633505  
633510  
+ 095011



DESERT EAGLE .50 AE  
090505



633505  
633510  
+ 095011



DESERT EAGLE .50 AE  
090507



633505  
633510  
+ 095011



DESERT EAGLE L6 .50 AE  
950504



633505  
633510  
+ 095011



DESERT EAGLE .50  
950525



633505  
633510  
+ 095011



DESERT EAGLE .50 AE RAIL  
950112



ITEM	POWER	FPS - m/s	ENERGY	MAG. CAPACITY	WEIGHT	LENGTH	POWER RANGE
950501 950503 950504	CO <sub>2</sub>	340 FPS - 105 m/s	1.1 J	21 BBs	1200 g	27 cm	35 m

ITEM	POWER	FPS - m/s	ENERGY	MAG. CAPACITY	WEIGHT	LENGTH	POWER RANGE
090505	CO <sub>2</sub>	360 FPS - 110 m/s	1.2 J	21 BBs	1123 g	27 cm	35 m
090507	CO <sub>2</sub>	340 FPS - 105 m/s	1.1 J	21 BBs	1123 g	27 cm	40 m
950525	CO <sub>2</sub>	330 FPS - 100 m/s	1 J	21 BBs	1300 g	27 cm	35 m
950112	SPRING	180 FPS - 55 m/s	0.3 J	190 BBs	340 g	27 cm	25 m

**BABY EAGLE**  
090300



633505  
633510  
+ 095013



**BABY EAGLE**  
950301



633505  
633510  
+ 095013



**DESERT EAGLE .50 AE**  
950900



+ 955005



**DESERT EAGLE .50 AE**  
950901



+ 955005



**BABY EAGLE**  
950302



633505  
633510  
+ 095013



**DESERT EAGLE KYDEX HOLDER**  
953003 - FITS ON ALL DESERT EAGLE



ITEM	POWER	FPS - m/s	ENERGY	MAG. CAPACITY	WEIGHT	LENGTH	POWER RANGE
090300	CO <sub>2</sub>	345 FPS - 105 m/s	1.2 J	15 BBs	750 g	30 cm	30 m
950301 950302	CO <sub>2</sub>	328 FPS - 100 m/s	1 J	15 BBs	750 g	30 cm	30 m

ITEM	POWER	FPS - m/s	ENERGY	MAG. CAPACITY	WEIGHT	LENGTH	POWER RANGE
950900 950901	AEP	213 FPS - 65 m/s	0.4 J	35 BBs	900 g	27 cm	15 m





In 1977, The French Army adopted the FAMAS (acronym from the french "Fusil d'Assaut de la Manufacture d'Armes de Saint-Etienne").

The FAMAS is a powerful and easy-to-use rifle, and is particularly appreciated for its ambidextrous design and the possibility of attaching a grenade launcher on it. He is also known for his high rate of fire, which amounts to 1,100 rounds per minute.

The FAMAS became the French weapon of reference, made in France, by a French company, for the French army.

En 1977, l'Armée Française adopte le FAMAS : Fusil d'Assaut de la Manufacture d'Armes de Saint-Etienne. Il remplace les différentes armes en dotation (le MAS 46/56, le pistolet-mitrailleur MAT 49 et le fusil-mitrailleur MAC 29).

Arme tactique puissante, facile d'utilisation et offrant la possibilité de tirer des grenades, elle séduit par son design ambidextre. Elle est aussi reconnue pour son taux élevé de tirs qui s'élève à plus de 1100 coups par minute.

Le FAMAS devient l'arme Française de référence, produite en France par une entreprise Française, pour l'Armée Française.

**FAMAS F1 EVO**  
400906



- 603239
- 603241
- 603260
- 639069
- 405001
- 405004
- 405005



**FAMAS F1**  
400907



- 603239
- 603241
- 603260
- 639069
- 405001
- 405004
- 405005



ITEM	POWER	FPS - m/s	ENERGY	MAG. CAPACITY	WEIGHT	LENGTH	POWER RANGE
400906 400907	AEG	361 FPS - 110 m/s	1.3 J	300 BBs	2860 g	76 cm	50 m





FN HERSTAL



The « Fabrique Nationale d'Armes de Guerre » was created the 15th of July 1889 to answer the need of the Belgian Army to modernize. An order of 150.000 rifles based on the Mauser M.89 system is passed, and the company is quickly named after the city where its factories are located and becomes the FN Herstal.

During the XXth century, the FNH was famous for its collaboration with American engineer John Moses Browning, and the work of Belgian engineer Dieudonné Saive, both of them being responsible for making some of the most iconic firearms of History.

For 130 years, the Herstal Group watchwords have been innovation, excellency and expert craftsmanship, to design, develop and produce a whole range of state-of-the-art pioneering weapons, which are being used for defence, security and civilian purposes.

La Fabrique Nationale d'armes de guerre voit le jour le 15 juillet 1889, répondant au besoin de l'armée belge de se moderniser. Une commande de 150 000 fusils basés sur le système du Mauser M.89 est alors passée, et le groupe est rapidement désigné par le nom de la ville où sont installées ses usines et devient la FN Herstal.

Au cours du XXème siècle, la FNH devient célèbre pour sa collaboration avec l'ingénieur américain John Moses Browning, mais aussi pour les travaux du belge Dieudonné Saive, tous deux à l'origine de certaines des armes les plus emblématiques de l'Histoire.

Depuis 130 ans, innovation, excellence et savoir-faire sont les maîtres-mots du Herstal Group qui conçoit, développe, et fabrique une gamme complète d'armes novatrices à la pointe de la technologie, que l'on retrouve aujourd'hui dans les domaines de la Défense, de la Sécurité et dans le secteur civil.

SCAR®-SC



FN HERSTAL

FN SCAR®-SC  
200838



639053  
205039

SUPPLIED WITH A GUN CASE - FOURNIE AVEC UNE MALLETTE - SUMINISTRADO CON UN MALETÍN



FN SCAR®-SC  
200828 (BLACK) / 200854 (FDE) / 200853 (GREY)



639053  
205043



ITEM	POWER	FPS - m/s	ENERGY	MAG. CAPACITY	WEIGHT	LENGTH	POWER RANGE
200838	AEG	330 FPS - 100 m/s	1 J	130 BBs	3100 g	54-65 cm	40 m
200828 200854 200853	AEG	330 FPS - 100 m/s	1 J	300 BBs	2900 g	54-65 cm	40 m



# SCAR®-SC & MINIMI® M249 SAW

FN SCAR®-SC  
200816



⚡ 639053

+ 205043

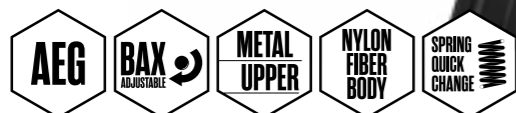

EXCLUSIVE PARTNERSHIP - PARTENARIAT EXCLUSIF - ASOCIACIÓN EXCLUSIVA

FN MINIMI® M249 SAW  
200817 (BLACK) / 200843 (FDE)



⚡ 603241  
603245

+ 68090  
68091  
57254  
205036



ITEM	POWER	FPS - m/s	ENERGY	MAG. CAPACITY	WEIGHT	LENGTH	POWER RANGE
200816	AEG	345 FPS - 105 m/s	1.2 J	400 BBs	3300 g	54-65 cm	45 m
200817 200843	AEG	330 FPS - 100 m/s	1 J	300 BBs	3800 g	115 cm	50 m



# MINIMI® M249 PARA

200839 (BLACK) / 200839 (BLACK: MOSFET) / 200842 (DUAL TONE: MOSFET)



⚡ 603241  
603245

+ 205035  
205036



FN MINIMI® M249 PARA  
200814 (BLACK) / 200841 (FDE)



⚡ 603241  
603245

+ 205035  
605009  
205036



ITEM	POWER	FPS - m/s	ENERGY	MAG. CAPACITY	WEIGHT	LENGTH	POWER RANGE
200839 200842	AEG	330 FPS - 100 m/s	1 J	300 BBs	3800 g	105 cm	50 m
200839	AEG	380 FPS - 115 m/s	1.4 J	300 BBs	3800 g	105 cm	50 m
200814 200841	AEG	330 FPS - 100 m/s	1 J	300 BBs	3800 g	105 cm	50 m



# MINIMI® M249 PARA & MK46

**FN MINIMI® M249 PARA**  
200951 (BLACK) / 200964 (FDE)



- ⚡ 603241
- ⚡ 603245
- + 605009

**AEG** **HOP UP ADJUSTABLE** **FULL METAL** **SPRING QUICK CHANGE**

**FN® MK46**  
200952 (BLACK) / 200971 (FDE)



- ⚡ 603241
- ⚡ 603245
- + 605009

**AEG** **HOP UP ADJUSTABLE** **FULL METAL** **SPRING QUICK CHANGE**

# SCAR®-HPR



**FN SCAR®-H PR**  
200826 (BLACK) / 200827 (FDE)



- ⚡ 639068
- ⚡ 639061
- ⚡ 639063
- ⚡ 639058
- + MAG-SCARH-500-BK
- + MAG-SCARH-500-DE

**AEG** **HOP UP ADJUSTABLE** **FULL SEMI SAFETY** **METAL UPPER**

**FN SCAR®-H TPR**  
200833 (BLACK) / 200846 (TAN)



- ⚡ 639053
- + 205041
- + 205042

**AEG** **BAX ADJUSTABLE** **METAL UPPER** **GAUSS MOSFET** **ELECTRONIC TRIGGER** **SPRING QUICK CHANGE** **T-DEAN**



EXCLUSIVE PARTNERSHIP - PARTENARIAT EXCLUSIF - ASOCIACIÓN EXCLUSIVA

ITEM	POWER	FPS - m/s	ENERGY	MAG. CAPACITY	WEIGHT	LENGTH	POWER RANGE
200951 200964 200952 200971	AEG	380 FPS - 115 m/s	1.4 J	60 BBs	5500 g	105 cm	50 m

ITEM	POWER	FPS - m/s	ENERGY	MAG. CAPACITY	WEIGHT	LENGTH	POWER RANGE
200827 200826	AEG	380 FPS - 115 m/s	1.4 J	500 BBs	3220 g	107 cm	60 m
200833 200846	AEG	330 FPS - 100 m/s	1J	180 BBs	4400 g	100 cm	45 m





FN HERSTAL

# SCAR®-H CQC

**FN SCAR®-H CQC**  
200823



639068  
639061  
639063  
639058

+ MAG-SCARH-500-BK



**FN SCAR®-H CQC**  
200825



639068  
639061  
639063  
639058

+ MAG-SCARH-500-DE



ITEM	POWER	FPS - m/s	ENERGY	MAG. CAPACITY	WEIGHT	LENGTH	POWER RANGE
200823 200825	AEG	380 FPS - 115 m/s	1.4 J	500 BBs	3100 g	85 cm	60 m



FN HERSTAL

# SCAR®-H STD

**FN SCAR®-H STD**  
200822



639068  
639061  
639063  
639058

+ MAG-SCARH-500-BK



**FN SCAR®-H STD**  
200824



639068  
639061  
639063  
639058

+ MAG-SCARH-500-DE



ITEM	POWER	FPS - m/s	ENERGY	MAG. CAPACITY	WEIGHT	LENGTH	POWER RANGE
200822 200824	AEG	380 FPS - 115 m/s	1.4 J	500 BBs	3150 g	85 cm	60 m



FN HERSTAL

# SCAR®-H

**FN SCAR®-H**  
20051



603513  
603514

+ 205023



**FN SCAR®-H**  
200550



603513  
603514

+ 205026



# SCAR®-H & SCAR®-L



FN HERSTAL

**FN SCAR®-H**  
200834 (BLACK) / 200835 (TAN)



639053

+ 205041

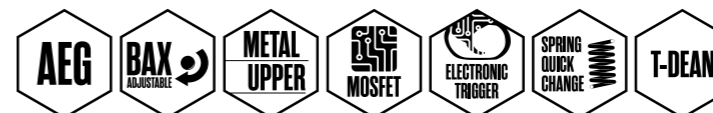

**FN SCAR®-L**  
200836 (BLACK) / 200837 (TAN)



639053

+ 205039

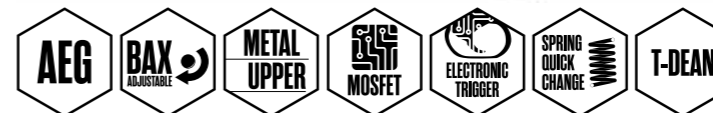

CYBERGUN



ARES

EXCLUSIVE PARTNERSHIP - PARTENARIAT EXCLUSIF - ASOCIACIÓN EXCLUSIVA

ITEM	POWER	FPS - m/s	ENERGY	MAG. CAPACITY	WEIGHT	LENGTH	POWER RANGE
200551 200550	GAS	393 FPS - 120 m/s	1.44 J	30 BBs	3100 g	86,5 cm	60 m

ITEM	POWER	FPS - m/s	ENERGY	MAG. CAPACITY	WEIGHT	LENGTH	POWER RANGE
200834 200835	AEG	330 FPS - 100 m/s	1 J	180 BBs	3350 g	83-88 cm	45 m
200836 200837	AEG	330 FPS - 100 m/s	1 J	130 BBs	3250 g	79-84 cm	45 m



# SCAR®-L

**FN SCAR®-L**  
200954 (FULL METAL) / 200961 (ABS)



⚡ 639061  
639063  
+ 185171  
185172



**FN SCAR®-L**  
200955 (FULL METAL) / 200962 (ABS)



⚡ 639061  
639063  
+ 185171  
185172



ITEM	POWER	FPS - m/s	ENERGY	MAG. CAPACITY	WEIGHT	LENGTH	POWER RANGE
<b>200954</b> <b>200955</b>	AEG	374 FPS - 114 m/s	1.3 J	350 BBs	3100 g	73 cm	60 m
<b>200961</b> <b>200962</b>	AEG	374 FPS - 114 m/s	1.3 J	350 BBs	2028 g	73 cm	60 m



# SCAR®-L CQC

**FN SCAR®-L CQC**  
200819



639068  
⚡ 639061  
639063  
639058  
+ 185171  
185172



**FN SCAR®-L CQC**  
200821



639068  
⚡ 639061  
639063  
639058  
+ 185171  
185172



ITEM	POWER	FPS - m/s	ENERGY	MAG. CAPACITY	WEIGHT	LENGTH	POWER RANGE
<b>200819</b> <b>200821</b>	AEG	380 FPS - 115 m/s	1.4 J	300 BBs	3100 g	73 cm	60 m





# SCAR®-L STD

**FN SCAR®-L STD**  
200818



- 639068
- 639061
- 639063
- 639058
- 185171
- 185172



**FN SCAR®-L STD**  
200820



- 639068
- 639061
- 639063
- 639058
- 185171
- 185172



ITEM	POWER	FPS - m/s	ENERGY	MAG. CAPACITY	WEIGHT	LENGTH	POWER RANGE
200818 200820	AEG	380 FPS - 115 m/s	1.4 J	300 BBs	3150 g	85 cm	60 m

# F2000®



**FN F2000® TACTICAL**  
200959 (BLACK) / 200960 (FDE)



- 603239
- 639065
- 639066
- 185171
- 185172



**FN F2000® TACTICAL**  
200801 (BLACK) / 200802 (FDE)



- 603239
- 639065
- 639066
- 185171
- 185172



ITEM	POWER	FPS - m/s	ENERGY	MAG. CAPACITY	WEIGHT	LENGTH	POWER RANGE
200959 200960	AEG	380 FPS - 115 m/s	1.4 J	470 BBs	3200 g	110 cm	60 m
200801 200802	AEG	360 FPS - 110 m/s	1.2 J	450 BBs	3305 g	110 cm	60 m

**FN P90®**  
KTAEG-FNP90-BK02 (EU) / BK03 (UK) / BK04 (IT) / BK08 (DE) / KTAEG-FNP90-ALP02 (WHITE)



+ KTP-KA225-02A

- AEG
- HOP UP ADJUSTABLE
- ABS
- SPRING QUICK CHANGE
- CNC MOSFET
- T-DEAN



EXCLUSIVE PARTNERSHIP IN EUROPE - PARTENARIAT EXCLUSIF EN EUROPE - ASOCIACIÓN EXCLUSIVA EN EUROPA

**FN P90® TACTICAL**  
200934 (BLACK) / 200956 (FDE)  
GAS VERSION: 200552 (FDE) / 200553 (BLACK)



603239  
603241

+ 205018

- AEG
- HOP UP ADJUSTABLE
- METAL GEAR
- ABS
- FULL SEMI SAFETY

**FN P90®**  
R4A1



639057  
639064

+ SSR90

- AEG
- HOP UP ADJUSTABLE
- NYLON FIBER BODY
- SPRING QUICK CHANGE
- ELECTRONIC TRIGGER
- CNC
- T-DEAN



EXCLUSIVE PARTNERSHIP - PARTENARIAT EXCLUSIF - ASOCIACIÓN EXCLUSIVA

ITEM	POWER	FPS - m/s	ENERGY	MAG. CAPACITY	WEIGHT	LENGTH	POWER RANGE
KTAEG-FNP90-BK KTAEG-FNP90-ALP02	AEG	400 FPS - 122 m/s	1.5 J	50-200 BBs	2300 g	50 cm	45 m
R4A1	AEG	320 FPS - 97 m/s	0.95 J	100 BBs	2100 g	48,7 cm	40 m

**FN P90® STANDARD**  
200994 (BLACK) / 200995 (FDE)



603239  
603241

+ 205018

- AEG
- HOP UP ADJUSTABLE
- METAL GEAR
- ABS
- FULL SEMI SAFETY

ITEM	POWER	FPS - m/s	ENERGY	MAG. CAPACITY	WEIGHT	LENGTH	POWER RANGE
200934 200956 200994 200995	AEG	425 FPS - 130 m/s	1.7 J	70 BBs	2230 g	51 cm	55 m
200552 200553	GAS	450 FPS - 140 m/s	1.9 J	50 BBs	2230 g	51 cm	50 m



# M4A1, SCAR®-L & SPR™ A2



**FN® M4A1**  
200521



**FN SLP™**  
200304



633505  
633510  
+ 285192



**FN SCAR®-L**  
200706 (BLACK) / 200705 (TAN)



**FN SPR™ A2**  
BLACK: 200712 (1,7 J) / 200715 (1 J)  
TAN: 200713 (1,7 J) / 200716 (1 J)  
OD: 200714 (1,7 J) / 200717 (1 J)



+ 205140



ITEM	POWER	FPS - m/s	ENERGY	MAG. CAPACITY	WEIGHT	LENGTH	POWER RANGE
<b>200521</b>	GAS	360 FPS - 110 m/s	1.2 J	30 BBs	2800 g	105 cm	45 m
<b>200712</b> <b>200713</b> <b>200714</b>	SPRING	440 FPS - 134 m/s	1.7 J	30 BBs	2700 g	114 cm	70 m
<b>200715</b> <b>200716</b> <b>200717</b>	SPRING	330 FPS - 100 m/s	1 J	30 BBs	2700 g	114 cm	50 m
<b>200304</b>	CO <sub>2</sub>	330 FPS - 100 m/s	1 J	30 BBs	2300 g	100 cm	30 m
<b>200705</b> <b>200706</b>	SPRING	310 FPS - 94 m/s	0.9 J	350 BBs	1810 g	81 cm	25 m

ACCESSORIES NOT INCLUDED - ACCESSOIRES NON INCLUS - ACCESORIOS NO INCLUIDOS





FN HERSTAL

# FNX™-45 & FNS™-9



FN HERSTAL

# FIVE-SEVEN®

**FNX™-45 TACTICAL**  
200508



603511  
603512  
+ 205019



**FNX™-45 TACTICAL**  
200503



603511  
603512  
+ 205017



**FN FIVE-SEVEN®**  
200507



633505  
633510  
+ 205013



**FN FIVE-SEVEN®**  
200510



603515  
+ 205029



**FNX™-45 CIVILIAN**  
200514



603511  
603512  
+ 205019



**FNS™-9**  
200511



603511  
603512  
+ 205028



**FN FIVE-SEVEN®**  
200524



603515  
+ 205029



**FNS™-9**  
200106



**FNS™-9**  
200107



ITEM	POWER	FPS - m/s	ENERGY	MAG. CAPACITY	WEIGHT	LENGTH	POWER RANGE
<b>200508</b> <b>200503</b>	GAS	328 FPS - 100 m/s	1 J	25 BBs	950 g	22 cm	35 m
<b>200514</b>	GAS	328 FPS - 100 m/s	1 J	25 BBs	800 g	20 cm	35 m
<b>200511</b>	GAS	295 FPS - 90 m/s	0.8 J	22 BBs	669 g	19,5 cm	35 m
<b>200106</b> <b>200107</b>	SPRING	230 FPS - 70 m/s	0.5 J	22 BBs	589 g	19,5 cm	15 m
<b>200507</b>	CO <sub>2</sub>	328 FPS - 100 m/s	1 J	22 BBs	794 g	21 cm	35 m
<b>200510</b>	GAS	311 FPS - 95 m/s	0.9 J	17 BBs	763 g	21,9 cm	35 m
<b>200524</b>	GAS	330 FPS - 100 m/s	1 J	17 BBs	763 g	21,9 cm	35 m



Born in 1919 in Russia, Mikhail Timofeievich Kalashnikov has always been an engineering enthusiast. When he was still a teenager, he first worked as a mechanic in a tractor station, and then as a rifle tester in a weapon factory, until he was drafted into the Red Army in 1938 as a tank crewman.

While he was recovering from injuries in 1941, Mikhail Kalashnikov frequently heard soldiers complaining about reliability issues on their infantry weapons. He then created a new type of submachine gun, and quickly made his way up to a weapon design office. By 1947, he created the Avtomat Kalashnikova, abbreviated as AK. The "Kalashnikov" was born, and officially adopted by the Soviet Union in 1949.

A lot of models followed, all praised for the same qualities: these guns are tough, reliable, easy to maintain and use, and most importantly, they are cheap. For these reasons, the AK became a favourite amongst guerilla fighters and countries in need of a simple but efficient assault rifle.

The Kalashnikov family is the biggest assault rifle group in the world, with more than 100 million units produced all over the globe, all variants combined.

Né en 1919 en Russie, Mikhail Timofeievich Kalashnikov a toujours été un passionné d'ingénierie mécanique. Alors qu'il n'est encore qu'un adolescent, il travaille comme mécanicien dans un dépôt de tracteurs, puis comme contrôleur qualité dans une usine d'armement soviétique, avant d'être enrôlé comme pilote de char en 1938.

Blessé en 1941 et mis en convalescence, il entend fréquemment les soldats se plaindre de la fiabilité de leurs armes d'infanterie. Il conçoit alors un nouveau type de pistolet-mitrailleur, ce qui lui vaut d'être muté dans un bureau de conception d'armes. En 1947, ses travaux aboutissent à la création de l'Avtomat Kalashnikova, abrégée en AK. La "Kalashnikov" est née, et est officiellement adoptée par l'Union Soviétique en 1949.

De nombreux modèles suivront et seront appréciés pour les mêmes qualités : leur robustesse, leur fiabilité, leur facilité d'entretien et d'utilisation, et surtout, leur faible coût. Ce sont autant de raisons qui en font l'arme idéale des guérilleros et des pays à la recherche d'une arme de dotation simple mais efficace.

Les AK forment la famille de fusils d'assaut la plus répandue dans le monde, avec plus de 100 millions d'unités produites partout autour du globe, toutes variantes confondues.



KALASHNIKOV AKS-74 MN  
120964



⚡ 603234  
+ 125025  
125026



KALASHNIKOV AKS 105  
120967



⚡ 603234  
+ 125025  
125026



KALASHNIKOV AK-74 MN  
120966



⚡ 603234  
+ 125025  
125026



KALASHNIKOV AK 105  
120968



⚡ 603234  
+ 125025  
125026



ITEM	POWER	FPS - m/s	ENERGY	MAG. CAPACITY	WEIGHT	LENGTH	POWER RANGE
120964	AEG	330 FPS - 100 m/s	1 J	450 BBs	3280 g	71-94 cm	45 m
120966	AEG	330 FPS - 100 m/s	1 J	450 BBs	3340 g	71-96 cm	45 m

ITEM	POWER	FPS - m/s	ENERGY	MAG. CAPACITY	WEIGHT	LENGTH	POWER RANGE
120967	AEG	330 FPS - 100 m/s	1 J	450 BBs	3080 g	60-83 cm	45 m
120968	AEG	330 FPS - 100 m/s	1 J	450 BBs	3140 g	60-84 cm	45 m



KALASHNIKOV AK47 TACTICAL  
120909



⚡ 603234  
+ 125008  
125017



KALASHNIKOV AK47  
120903



⚡ 603239  
603241  
+ 125008  
125009  
125017



KALASHNIKOV AK47 AIMS  
120922



⚡ 603234  
603258  
+ 125019



KALASHNIKOV AKS74U  
120912



⚡ 603258  
603234  
+ 125008  
125009  
125017



KALASHNIKOV AK47 TACTICAL  
120944



⚡ 603241  
603239  
603260  
+ 125017



KALASHNIKOV AK47  
120916



⚡ 603234  
603241  
+ 125017  
125008



KALASHNIKOV AK47 BETA SPETSNAZ  
120913



- ⚡ 603260
- ⚡ 603239
- ⚡ 603241
- ⚡ 125008
- ⚡ 125009
- ⚡ 125017



KALASHNIKOV AK BETA SPESNAZ  
120707



KALASHNIKOV AK47  
120703



KALASHNIKOV AKM  
120963



- ⚡ 603234
- ⚡ 125025
- ⚡ 125026



ITEM	POWER	FPS - m/s	ENERGY	MAG. CAPACITY	WEIGHT	LENGTH	POWER RANGE
120964	AEG	330 FPS - 100 m/s	1 J	450 BBs	3280 g	71-94 cm	45 m
120966	AEG	330 FPS - 100 m/s	1 J	450 BBs	3340 g	71-96 cm	45 m
120967	AEG	330 FPS - 100 m/s	1 J	450 BBs	3080 g	60-83 cm	45 m
120968	AEG	330 FPS - 100 m/s	1 J	450 BBs	3140 g	60-84 cm	45 m
120913	AEG	389 FPS - 117 m/s	1.4 J	550 BBs	2350 g	71 cm	60 m
120912	AEG	384 FPS - 117 m/s	1.36 J	430 BBs	2950 g	73 cm	60 m
120944	AEG	377 FPS - 115 m/s	1.3 J	550 BBs	2300 g	87,5 cm	55 m
120916	AEG	377 FPS - 115 m/s	1.3 J	600 BBs	3550 g	89,7 cm	60 m
120909	AEG	389 FPS - 117 m/s	1.4 J	550 BBs	3100 g	93 cm	60 m
120903	AEG	377 FPS - 115 m/s	1.3 J	600 BBs	2760 g	87,5 cm	60 m
120922	AEG	410 FPS - 125 m/s	1.6 J	550 BBs	3510 g	90 cm	60 m
120707	SPRING	233 FPS - 68 m/s	0.7 J	300 BBs	811 g	70 cm	30 m
120703	SPRING	275 FPS - 84 m/s	0.5 J	300 BBs	1800 g	87,5 cm	30 m
120963	AEG	330 FPS - 100 m/s	1 J	450 BBs	3040 g	92 cm	45 m





SR



MAUSER SR  
140715



MAUSER SR  
140716



MAUSER SR  
140717



The historic German Mauser Waffenfabrik is created in 1811 by order of the King Frederic the 1st of Württemberg and named The Royal Manufactory of Obendorf. The company stands out particularly in 1898 thanks to the Gewehr 98 Rifle that became the ordinance weapon of the German Army, and a second time in 1935 thanks to the Karabiner 98k which was the standard rifle for infantrymen throughout WWII. Mauser is today renowned for the high quality of its bolt action rifles intended for precision shooting as well as for hunting, which now represents its main markets.

La fabrique historique allemande : Mauser Waffenfabrik est créée en 1811 sur ordonnance du roi Frédéric 1er de Wurtemberg sous le nom de Manufacture d'armes royale d'Obendorf. L'entreprise s'est particulièrement démarquée en 1898, avec son fusil Gewehr 98 qui fut adopté comme arme d'ordonnance de l'armée allemande ainsi qu'en 1935 avec le Karabiner 98k qui fut le fusil standard du fantassin pendant toute la Seconde Guerre mondiale. Mauser est aujourd'hui réputée pour la haute qualité de ses fusils à verrou destinés au tir de précision aussi bien qu'à la chasse, qui représente désormais ses principaux marchés.

ITEM	POWER	FPS - m/s	ENERGY	MAG. CAPACITY	WEIGHT	LENGTH	POWER RANGE
140715 140716 140717	SPRING	400 FPS - 120 m/s	1.5 J	20 BBs	700 g	114 cm	30 m





**PGM 338**  
290501



603513  
603514  
+ 295001



**PGM 338**  
290502



603513  
603514  
+ 295001



In 1991, the RAID (special forces of the French Police) is equipped with a custom-made precision rifle by the talented gunsmith Gilles Payen: the Ultima Ratio.

The success of this weapon was such Mr. Payen decided to found PGM Precision in 1993 with his partners MM. Gonnet and Morier, in Poisy in Haute-Savoie. The three men then began to create other innovative precision rifles, such as the 12.7 mm caliber Hecate II which was officially adopted by the French infantry and special forces in 1995, but also the .308 Win for the Swiss Police, the PGM338 or the LUDIS for sports shooters.

PGM Precision rifles are used in many military and police forces around the world, and are unanimously appreciated by their users thanks to their strength and high precision.

En 1991, le RAID s'équipe d'un fusil de précision fabriqué sur-mesure par le talentueux armurier Gilles Payen : l'Ultima Ratio.

Face au succès de son arme, M. Payen décide de fonder PGM Précision en 1993 avec ses associés MM. Gonnet et Morier, à Poisy en Haute-Savoie. Les trois hommes commencent alors à créer d'autres fusils de précision innovants, comme l'Hécate II de calibre 12,7 mm qui fut officiellement adopté par l'infanterie et les forces spéciales françaises en 1995, mais aussi le Mini Hécate I en calibre .308 Win à destination de la police suisse, le PGM338 ou encore le LUDIS pour tireurs sportifs.

Les fusils PGM Précision sont en utilisation dans de nombreuses armées et services de police de par le monde, et font l'unanimité auprès de leurs utilisateurs grâce à leur robustesse et leur grande précision.



SUPPLIED WITH A GUN CASE - FOURNIE AVEC UNE MALLETTE - SUMINISTRADO CON UN MALETÍN

ITEM	POWER	FPS - m/s	ENERGY	MAG. CAPACITY	WEIGHT	LENGTH	POWER RANGE
<b>290501</b> <b>290502</b>	GAS	328 FPS - 100 m/s	1 J	19 BBs	7000 g	122 cm	60 m



# MP40 & MP44



Hugo SCHMEISSER was born in Germany on September 24, 1884. He can be considered as the John Browning of Germany. In order to stop the heavy losses resulting from trench warfare (1915-1917), the German High Command decided to design an easy to handle weapon capable of rapid fire. In 1918, Hugo SCHMEISSER and the Bergmann company released the MP18/1, of which some 35 000 units were produced. Despite the German capitulation and the restrictions imposed by Treaty of Versailles, Hugo SCHMEISSER secretly developed the MP28, MP34 and MP36. This work led to the famous MP40. He was also responsible for the Sturmgewehr 44. He was forcibly recruited by the Red Army from 1946 to 1952 to participate in the development of arms.

Hugo SCHMEISSER est né en Allemagne le 24 septembre 1884. Il peut être considéré comme le John Browning de l'Allemagne. Afin de mettre un terme aux lourdes pertes résultant de la guerre des tranchées (1915-1917), le haut commandement allemand décide de concevoir une arme facile à manier et capable de tirer rapidement. En 1918, Hugo SCHMEISSER et la société Bergmann lancent le MP18/1, qui sera produit à 35 000 exemplaires. Malgré la capitulation allemande et les restrictions imposées par le Traité de Versailles, Hugo SCHMEISSER développe secrètement les MP28, MP34 et MP36. Ces travaux ont abouti au célèbre MP40. Il est également responsable du Sturmgewehr 44. Il est recruté de force par l'Armée rouge de 1946 à 1952 pour participer au développement d'armes.

**SCHMEISSER MP40**  
300001 (AEG) / 300003 (CO<sub>2</sub>)



603513  
603514

305006



**SCHMEISSER MP44**  
300002



603239  
603246  
603260

305005



ITEM	POWER	FPS - m/s	ENERGY	MAG. CAPACITY	WEIGHT	LENGTH	POWER RANGE
<b>300001</b>	AEG	360 FPS - 110 m/s	1.2 J	50 BBs	3000 g	61-83 cm	40 m
<b>300003</b>	CO <sub>2</sub>	360 FPS - 110 m/s	1.2 J	30 BBs	3200 g	61 - 83 cm	40 m
<b>300002</b>	AEG	400 FPS - 120 m/s	1.5 J	300 BBs	4200 g	94 cm	45 m





**SPRINGFIELD ARMORY XD-M® 3.8"**  
SA-XDM38GBB6-B (BLACK) / SA-XDM38GBB6-S (SILVER)



603511  
603512

SA-XDMCO2BB6-MB (CO<sub>2</sub>)



**SPRINGFIELD ARMORY XD-M® 4.5"**  
SA-XDM45GBB6-B (BLACK) / SA-XDM45GBB6-S (SILVER)



603511  
603512

SA-XDMCO2BB6-MB (CO<sub>2</sub>)



**SPRINGFIELD ARMORY XD-E™ 4.5"**  
SA-XDE6BB-BE



633505  
633510

SA-XDE6BB-ME (CO<sub>2</sub>)



Springfield armory is one of the most prestigious gun manufacturers in the US. Founded in 1777 by decision of George Washington for the Continental Army during the American Civil War, Springfield Armory made famous weapons such as the M1903, the M14 and the M1 Garand, for the American government until it has been shut down in 1968 during Vietnam War.

Reopened in 1974 thanks to the Reese Family, Springfield Armory now produces some of the most popular guns on the market, such as the M1 Garand (since its reopening), the SAINT AR-15 (since 2016), the XD pistol (since 2001) and variants of AR15 and M1911.

Springfield Armory est l'une des plus prestigieuses manufactures d'armes des États-Unis. Fondée en 1777 sur décision de George Washington, elle équipa l'armée continentale tout au long de la guerre d'indépendance, et continua d'approvisionner les différents corps de l'armée américaine jusqu'à la guerre du Vietnam, en concevant et fabriquant des armes aussi mythiques que le Springfield Model 1861, le Model 1863 et sa conversion Trapdoor, le M1903, le M1 Garand, le M14, et tant d'autres.

Fermée et démantelée en 1968, l'héritage de la fabrique fédérale fut sauvé en 1974 par la famille Reese. Springfield Armory, Inc. produit aujourd'hui encore les armes qui ont fait la renommée de la fabrique originelle, telle que le M1A (une variante de M14), le pistolet semi-automatique XD, ainsi que des variantes repensées d'AR-15 (la gamme SAINT) et de M1911.

ITEM	POWER	FPS - m/s	ENERGY	MAG. CAPACITY	WEIGHT	LENGTH	POWER RANGE
<b>XD-M® 3.8"</b>	GAS	280 FPS - 85 m/s	0.9 J	22 BBs	875 g	18 cm	30 m
<b>XD-M® 4.5"</b>	GAS	280 FPS - 85 m/s	0.8 J	22 BBs	795 g	20 cm	30 m
<b>XD-E™ 4.5"</b>	CO <sub>2</sub>	330 FPS - 100 m/s	1 J	22 BBs	795 g	20 cm	35 m





In 1859, Swiss Arms won the federal army's trials to modernize its smooth bore rifles. The company then changed its name to become the Schweizerische Industrie Gesellschaft, better known as SIG.

SIG has made a lot of successful firearms during the past 140 years: the Vetterli rifles, the P210 handgun, the SG550 assault rifles family, the P220 handgun and its successors the P226 and its derivatives...

The company is well known for its excellency in gunsmithing, and its use of cutting-edge technology combined with its decades-long experience.

After SIG sold its small arms division in 2000, the last one took the name SWISS ARMS AG and has kept producing Swiss army's assault rifles and SP2022 handguns for French police and gendarmerie forces, as well as tactical equipment and airguns.

En 1859, l'entreprise suisse remporte l'appel d'offre de l'armée fédérale pour moderniser ses fusils à âme lisse. Swiss Arms change alors de nom et devient la Schweizerische Industrie Gesellschaft, mieux connue sous son acronyme SIG.

SIG conçoit de nombreuses armes à succès au cours des 140 dernières années : la gamme des fusils Vetterli, le P210, la gamme de fusils d'assaut SG550, ainsi que le P220 et ses successeurs le P226 et dérivés... La marque est réputée pour la qualité de ses usinages et ses procédés combinant une technologie de pointe à un savoir-faire acquis au cours de plusieurs décennies.

En 2000, après la vente de sa division armes légères, l'entreprise renommée SWISS ARMS AG continue de produire les fusils d'assaut de l'armée suisse et les pistolets SP2022 de la police et de la gendarmerie françaises, tout en proposant une gamme d'équipements tactiques et d'armes à air comprimé.

**SWISS ARMS MILE**  
280108



+ 285011



**SWISS ARMS MILE**  
280136



+ 285011



**SWISS ARMS MILE**  
280301



✓ 633505  
633510

+ 285044  
285045



**SWISS ARMS MILE**  
280325



ITEM	POWER	FPS - m/s	ENERGY	MAG. CAPACITY	WEIGHT	LENGTH	POWER RANGE
<b>280108</b>	SPRING	230 FPS - 70 m/s	0.5 J	24 BBs	589 g	18,5 cm	15 m
<b>280136</b>	SPRING	256 FPS - 78 m/s	0.6 J	24 BBs	482 g	19,8 cm	15 m
<b>280301</b>	CO <sub>2</sub>	305 FPS - 93 m/s	0.9 J	15 BBs	710 g	18,8 cm	30 m
<b>280325</b>	CO <sub>2</sub>	310 FPS - 95 m/s	0.9 J	15 BBs	710 g	19 cm	35 m

THE TRADE DRESS OF THESE PRODUCTS IS OWNED BY SIG SAUER, INC., USED UNDER LICENSE.

**SWISS ARMS NAVY PISTOL**  
280569



603511  
603512  
+ 205028



**SWISS ARMS NAVY PISTOL RAIL**  
280570



603511  
603512  
+ 205028



**SWISS ARMS NAVY PISTOL**  
280968 / 280969 (MOSFET)



+ 285195



**SWISS ARMS NAVY PISTOL AIRLINE**  
280579



633505  
633510  
+ 285039



**SWISS ARMS NAVY PISTOL .40**  
280571



603511  
603512  
+ 205028



**SWISS ARMS NAVY PISTOL .40 RAIL**  
280572



603511  
603512  
+ 205028



**SWISS ARMS BLACK EAGLE M6**  
280726



+ 285064



**SWISS ARMS NAVY PISTOL XXL**  
280514



633505  
633510  
+ 285039



**SWISS ARMS NAVY PISTOL**  
280114 / 280002 (ABS)



+ 285011



ITEM	POWER	FPS - m/s	ENERGY	MAG. CAPACITY	WEIGHT	LENGTH	POWER RANGE
<b>280569</b> <b>280570</b>	GAS	280 FPS - 85 m/s	0.9 J	22 BBs	875 g	19,5 cm	30 m
<b>280571</b> <b>280572</b>	GAS	280 FPS - 85 m/s	0.8 J	22 BBs	795 g	18 cm	30 m
<b>280514</b>	CO <sub>2</sub>	330 FPS - 100 m/s	1 J	24 BBs	1137 g	22,5 cm	35 m
<b>280114</b>	SPRING	256 FPS - 78 m/s	0.6 J	24 BBs	482 g	19,8 cm	15 m
<b>280968</b> <b>280969</b>	AEP	213 FPS - 65 m/s	0.4 J	30 BBs	830 g	19 cm	20 m
<b>280579</b>	CO <sub>2</sub>	390 FPS - 120 m/s	1.4 J	26 BBs	1140 g	22 cm	35 m
<b>280726</b>	SPRING	330 FPS - 100 m/s	1 J	17 BBs	763 g	110 cm	40 m

THE TRADE DRESS OF THESE PRODUCTS IS OWNED BY SIG SAUER, INC., USED UNDER LICENSE.





For the Tanfoglio family, guns are a legacy dating back to the early 1900s. Based in the Italian region of Brescia, the company's first break came in 1948, when Giuseppe Tanfoglio merged his company with the Sabatti family, forming a new firm called SATA. This new company first focused on building separate parts, before producing their first 6.35 mm semi-automatic pistol in 1958 as well as a few hunting rifles.

At the end of the 60s, Giuseppe Tanfoglio decided to create his own company, named after his family. He mostly focused on producing firearms for sports, particularly for IPSC and IDPA categories. His guns have been used to win 3 world cups, 2 European titles and many national championships worldwide, showing the high quality of the firm's products.

Depuis le début du siècle dernier, la famille Tanfoglio a toujours fabriqué des armes à feu. Tout commence avec Bortolo Tanfoglio, qui autour des années 1900 fabriquait et assemblait des platines pour les armuriers de sa province de Brescia, en Italie. Marchant dans les pas de son père, Giuseppe reprend l'affaire familiale et en 1948, il s'associe à la famille Sabatti pour fonder l'armurerie SATA, avant de se remettre à son compte en 1960, fort de l'expérience acquise au cours de ces 12 années.

Ses enfants Lino, Marilena et Massimo Tanfoglio renomment l'entreprise Fratelli Tanfoglio en 1969, donnant à la société l'image que nous lui connaissons aujourd'hui. Produisant au départ des revolvers et des derringers pour assurer la continuité des traditions familiales, la marque s'oriente au cours des décennies suivantes vers des pistolets semi-automatiques allant du .22 LR au .45 ACP en passant par le 9mm Parabellum.

Les pistolets Tanfoglio sont aujourd'hui très appréciés par les tireurs sportifs du monde entier, remportant 3 Championnats du Monde et 2 Championnats d'Europe IPSC.

TANFOGLIO GOLD CUSTOM (NO RAIL)  
350503



- 633505
- 633510
- + 355000



TANFOGLIO LIMITED CUSTOM (COMPENSATOR)  
350505



- 633505
- 633510
- + 355000



ITEM	POWER	FPS - m/s	ENERGY	MAG. CAPACITY	WEIGHT	LENGTH	POWER RANGE
350503 350505	CO <sub>2</sub>	330 FPS - 100 m/s	1 J	18 BBs	1400 g	22 cm	35 m





THOMPSON M1928  
430983



⚡ 639062  
639064  
+ 435004



THOMPSON M1928  
430901



⚡ 639062  
639064  
+ 435004



Auto-Ordnance Corporation was created in 1916 by John T. Thompson willing to enforce its vision of modern firearm. 3 years later, in 1919, the company releases its first submachine gun: the Thompson 1919 Model.

A new gun style is born and with it a whole new range of iconic weapons such as the «Tommy Gun», the M1921 or the M1928 US Navy model.

During World War II, more than 1.4 million of Thompson guns were made.

Auto-Ordnance Corporation est créée en 1916, alors que son créateur, l'américain John T. Thompson veut imposer sa vision de l'arme moderne. Trois ans plus tard, en 1919, il sort son premier modèle de pistolet-mitrailleur : la Thompson modèle 1919.

Un nouveau style d'armes voit le jour et avec lui toute une déclinaison du modèle emblématique telle que la "Tommy gun", la "M1921" ou bien l'US Navy model de 1928.

Pendant la Seconde Guerre Mondiale, plus de 1,4 millions de Thompson ont été fabriquées dans le monde.

ITEM	POWER	FPS - m/s	ENERGY	MAG. CAPACITY	WEIGHT	LENGTH	POWER RANGE
430983	AEG	360 FPS - 110 m/s	1.2 J	450 BBs	3900 g	87 cm	45 m
430901	AEG	373 FPS - 113 m/s	1.3 J	450 BBs	3400 g	87 cm	45 m

THOMPSON M1A1  
430900



- 603239
- 603241
- 603260
- 639066
- 435003
- 435002

AEG BAX ADJUSTABLE METAL BODY METAL GEAR

AO 1911 VICTORY GIRL  
430501



- 603511
- 603512
- 185174

GREEN GAS BAX ADJUSTABLE BLOW BACK FULL METAL REAL WOOD

AO 1911 FLY GIRL  
430502



- 603511
- 603512
- 185174

GREEN GAS BAX ADJUSTABLE BLOW BACK FULL METAL REAL WOOD

THOMPSON M1A1  
430500



- 603513
- 603514
- 435011

GREEN GAS BAX ADJUSTABLE BLOW BACK METAL BODY

AO 1911 SQUADRON  
430503



- 603511
- 603512
- 185174

GREEN GAS BAX ADJUSTABLE BLOW BACK FULL METAL REAL WOOD

AO M1911A1  
430505 (MATT BLACK WOOD) / 430506 (MARBLE WOOD)



- 603511
- 603512
- 185174

GREEN GAS BAX ADJUSTABLE BLOW BACK FULL METAL REAL WOOD

ITEM	POWER	FPS - m/s	ENERGY	MAG. CAPACITY	WEIGHT	LENGTH	POWER RANGE
430900	AEG	360 FPS - 110 m/s	1.2 J	450 BBs	3200 g	80,5 cm	45 m
430500	GAS	330 FPS - 100 m/s	1 J	450 BBs	3200 g	80,5 cm	45 m

ITEM	POWER	FPS - m/s	ENERGY	MAG. CAPACITY	WEIGHT	LENGTH	POWER RANGE
430501 430502 430503	GAS	330 FPS - 100 m/s	1 J	15 BBs	800 g	21 cm	30 m
430505 430506	GAS	330 FPS - 100 m/s	1 J	15 BBs	800 g	21 cm	30 m





Armorer Works Custom is a 4.5 mm and 6 mm high end airsoft guns manufacturer, inspired by the real firearms market and offer replicas for airsoft games, IPSC and collecting.

AW Custom gun's look ranges from modern to sporting and can even be futuristic, offering a large choice of customization options, like micro red sight site, muzzle brake and optical fiber sights.

Armorer Works Custom est un fabricant de répliques custom haut de gamme en 4.5 mm et 6 mm, s'inspirant du marché des véritables armes à feu pour proposer des modèles destinés au jeu, à l'IPSC et à la collection.

Les répliques AW Custom oscillent entre les styles moderne, sportif voire futuriste, en offrant un large panel d'options de personnalisation qui vont de la présence d'un emplacement pour micro dot sight à celle d'un compensateur en passant par des organes de visée en fibre de verre.

**AW CUSTOM VX8**  
AW-VX8100 (BLACK) / AW-VX8101 (TAN)



603511  
603512  
+ AW-VXMG07



**AW CUSTOM VX8**  
AW-VX8200 (BLACK) / AW-VX8201 (TAN)



603511  
603512  
+ AW-VXMG07



**AW CUSTOM VX8**  
AW-VX8400 (BLACK) / AW-VX8401 (TAN)



603511  
603512  
+ AW-VXMG08



**AW CUSTOM VX8**  
AW-VX8500 (BLACK) / AW-VX8501 (TAN)



603511  
603512  
+ AW-VXMG08



**AW CUSTOM VX8**  
AW-VX8300 (BLACK) / AW-VX8301 (TAN)



603511  
603512  
+ AW-VXMG07



**AW CUSTOM VX8**  
AW-VX8600 (BLACK) / AW-VX8601 (TAN)



603511  
603512  
+ AW-VXMG08



ITEM	POWER	FPS - m/s	ENERGY	MAG. CAPACITY	WEIGHT	LENGTH	POWER RANGE
VX8 SERIES	GAS	290 FPS - 90 m/s	0.8 J	27 BBs	740 g	19,8 cm	30 m

ITEM	POWER	FPS - m/s	ENERGY	MAG. CAPACITY	WEIGHT	LENGTH	POWER RANGE
VX8 SERIES	GAS	290 FPS - 90 m/s	0.8 J	27 BBs	740 g	19,8 cm	30 m



**AW CUSTOM VX7**  
 AW-VX7100 (BLACK) / AW-VX7101 (TAN)  
 AW-VX7110 (BLACK) / AW-VX7111 (TAN) (PRECUT)



603511  
 603512  
 AW-VXMG07  
 AW-VXMG05 (PRECUT)



**AW CUSTOM VX7**  
 AW-VX7300 (BLACK) / AW-VX7301 (TAN)  
 AW-VX7310 (BLACK) / AW-VX7311 (TAN) (PRECUT)



603511  
 603512  
 AW-VXMG07  
 AW-VXMG05 (PRECUT)



**AW CUSTOM VX9**  
 AW-VX9100 (BLACK) / AW-VX9101 (TAN)  
 AW-VX9110 (BLACK) / AW-VX9111 (TAN) (PRECUT)



603511  
 603512  
 AW-VXMG08  
 AW-VXMG06 (PRECUT)



**AW CUSTOM VX9**  
 AW-VX9200 (BLACK) / AW-VX9201 (TAN)  
 AW-VX9210 (BLACK) / AW-VX9211 (TAN) (PRECUT)



603511  
 603512  
 AW-VXMG08  
 AW-VXMG06 (PRECUT)



**AW CUSTOM VX7**  
 AW-VX7200 (BLACK) / AW-VX7201 (TAN)  
 AW-VX7210 (BLACK) / AW-VX7211 (TAN) (PRECUT)



603511  
 603512  
 AW-VXMG07  
 AW-VXMG05 (PRECUT)



**AW CUSTOM VX9**  
 AW-VX9300 (BLACK) / AW-VX9301 (TAN)  
 AW-VX9310 (BLACK) / AW-VX9311 (TAN) (PRECUT)



603511  
 603512  
 AW-VXMG08  
 AW-VXMG06 (PRECUT)



ITEM	POWER	FPS - m/s	ENERGY	MAG. CAPACITY	WEIGHT	LENGTH	POWER RANGE
<b>VX7 SERIES</b>	GAS	290 FPS - 90 m/s	0.8 J	27 BBs	740 g	19,8 cm	30 m

ITEM	POWER	FPS - m/s	ENERGY	MAG. CAPACITY	WEIGHT	LENGTH	POWER RANGE
<b>VX9 SERIES</b>	GAS	290 FPS - 90 m/s	0.8 J	27 BBs	740 g	19,8 cm	30 m



ARCHON FIREARMS



# ARCHON TYPE B



ARCHON FIREARMS

**ARCHON TYPE B**  
AR-TB0100



603511  
603512

AR-TBMG01



**ARCHON TYPE B**  
AR-TB0101



603511  
603512

AR-TBMG01



Archon Type B Pistol evolves from Italian firm Arsenal Firearms' Strike One.

Strike One pistol introduces «AF-Speedlock®» patented system in which the barrel moves back and forth without rotating or tilting. Russian armed Forces ordered a full-auto version of the pistol able to shoot their 9x19 mm ammunition (7N21 and 7N31 close from .357 SIG).

In 2016, partnership between Arsenal Firearms and Salient Arms International gives birth to the Stryk pistol, a reshaped version of the Strike One available in a full-size version, the Stryk-A, and a compact version, the Stryk-B.

In 2018 between Arsenal Firearms USA becomes Archon Firearms. Stryk-B pistol is renamed to Archon Type B.

These pistols are produced by RUAG group in Germany and Hungary.

Le pistolet Archon Type B est une évolution du Strike One conçu par la société italienne Arsenal Firearms.

Le Strike One introduit le système breveté «AF-Speedlock®» où le canon recule en un mouvement linéaire, d'avant en arrière, sans rotation ni basculement. Les forces armées russes commanderont une version full-auto de ce pistolet capable de chamberer leurs munitions 9x19 mm (7N21 et 7N31 proche du .357 SIG).

En 2016, le partenariat entre Arsenal Firearms et Salient Arms International fait naître le Stryk, une version redessinée du Strike One, deux versions : le Stryk-A en full-size, et le Stryk-B en compact.

En 2018, Arsenal Firearms USA devient Archon Firearms. Le Stryk-B et rebaptisé Archon Type B.

Ces pistolets sont fabriqués par le groupe RUAG en Allemagne et Hongrie.

ITEM	POWER	FPS - m/s	ENERGY	MAG. CAPACITY	WEIGHT	LENGTH	POWER RANGE
AR-TB0100 AR-TB0101	GAS	300 FPS - 90 m/s	1J	15 BBs	700 g	19,3 cm	30 m





## ACCESSORIES

With the Swiss Arms range of accessories, you get the same efficiency and quality that have made the reputation of Swiss products. Using the highest technology, each product has been designed to offer top performances. Every new accessory has also been thoroughly tested to ensure reliability and long product life. Swiss Arms Accessories: simply the highest performances and most comprehensive range of accessories to personalize and upgrade your equipment.

## ACCESSOIRES

La gamme d'accessoires Swiss Arms vous garantit la même efficacité et qualité qui ont fait la réputation des produits suisses. Le haut niveau de technologie avec lequel les produits ont été conçus offre un haut niveau de performance. Les nouveaux produits sont rigoureusement testés pour nous assurer fiabilité et longévité. Les accessoires Swiss Arms sont l'alliage d'une exigence de performance et la compréhension de chaque besoin unique pour fournir une gamme à la hauteur des désirs de personnalisation et d'upgrade.





**BIODEGRADABLE BBs**

- 553001 - 0.20 g - BAG - 3200 BBs
- 553002 - 0.23 g - BAG - 3200 BBs
- 553003 - 0.25 g - BAG - 3200 BBs
- 553004 - 0.20 g - JAR - 2000 BBs
- 553005 - 0.25 g - JAR - 1000 BBs

**CANiK**



**BIODEGRADABLE BBs**

- KA-BB-04-WH - 0.20 g - BAG - 1 kg
- KA-BB-22-WH - 0.23 g - BAG - 1 kg
- KA-BB-05-WH - 0.25 g - BAG - 1 kg
- KA-BB-06-WH - 0.28 g - BAG - 1 kg
- KA-BB-07-WH - 0.30 g - BAG - 1 kg
- KA-BB-33-WH - 0.32 g - JAR - 1000 BBs
- KA-BB-10-WH - 0.30 g - JAR - 500 BBs

**SWISS ARMS**

**NON-BIODEGRADABLE BBs**

- KA-BB-01-WH - 0.20 g - BAG - 1 kg
- KA-BB-23-WH - 0.23 g - BAG - 1 kg
- KA-BB-02-WH - 0.25 g - BAG - 1 kg
- KA-BB-03-WH - 0.28 g - BAG - 1 kg
- KA-BB-18-WH - 0.36 g - BAG - 1000 BBs
- KA-BB-34-WH - 0.36 g - JAR - 1000 BBs
- KA-BB-19-WH - 0.40 g - BAG - 1000 BBs
- KA-BB-35-WH - 0.40 g - JAR - 1000 BBs
- KA-BB-11-WH - 0.30 g - JAR - 500 BBs



**BIODEGRADABLE BBs**

- 183024 - 0.20 g - BAG - 3200 BBs
- 183025 - 0.23 g - BAG - 3200 BBs
- 183026 - 0.25 g - BAG - 3200 BBs

**COLT**



**BIODEGRADABLE BBs**

- 805025 - 0.20 g - BAG - 1 kg
- 805034 - 0.23 g - BAG - 1 kg
- 804028 - 0.25 g - BAG - 1 kg
- 804031 - 0.28 g - BAG - 1 kg
- 803026 - 0.30 g - BAG - 1 kg

**BIOVAL**



**BIODEGRADABLE BBs**

- 123600 - 0.20 g - BAG - 3200 BBs
- 123705 - 0.23 g - BAG - 3200 BBs
- 123601 - 0.25 g - BAG - 3200 BBs
- 123405 - 0.20 g - JAR - 2000 BBs
- 123406 - 0.25 g - JAR - 2000 BBs

**KALASHNIKOV**

**NON-BIODEGRADABLE BBs**

- 123500 - 0.20 g - BAG - 1 kg
- 123400 - 0.25 g - BAG - 1 kg
- 123402 - 0.12 g - JAR - 2000 BBs (Yellow BBs)
- 123401 - 0.20 g - JAR - 2000 BBs
- 123407 - 0.25 g - JAR - 2000 BBs
- 123408 - 0.20 g - JAR - 1000 BBs (Red BBs)



CHRONOGRAPH  
697005

**CHRONOGRAPH**

With OLED Display, bipod included  
Avec écran OLED, bipied inclus  
Con pantalla OLED, bipode incluido





LiPo 7,4 V



NiMh 8,4 V

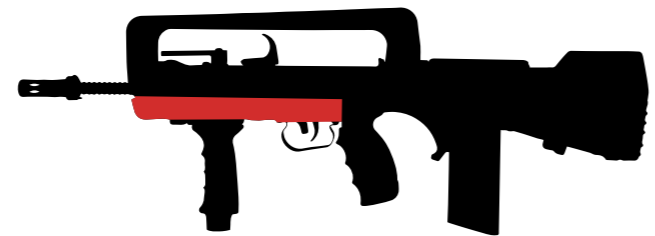

NiMh 9,6 V



LiPo 11,1 V



**GREEN GAS**



LIGHT 603515    GREEN GAS 603511    GREEN GAS 603512    HEAVY GAS 603513    HEAVY GAS 603514

**CO<sub>2</sub>, GAS & OIL**



1x CO<sub>2</sub> 633500

5x LUBRICATION CO<sub>2</sub> 633525

5x CO<sub>2</sub> 633504

10x CO<sub>2</sub> 633510

25x CO<sub>2</sub> 633505

EXTREME GAS 603506

APS3 LUBRICANT SPRAY 603559

**CHARGERS & ADAPTERS**



NiMH CHARGER 603357

NiMH AUTO CHARGER 603367

NiMH, LiPo, LiFe CHARGER 603368

LiPo CHARGER 603361

Mini Tamiya > Tamiya Large 603233

Tamiya Large > Mini Tamiya 603240

Tamiya Large > T-DEAN 603346

Mini Tamiya > T-DEAN 603347

**TARGETS**



CONICAL TARGET 603418

SQUARE TARGET 603419

SQUARE TARGET 603427

NET TARGET 603404

5 TARGETS 603426

TILTING TARGETS 603428

TARGETS WHEEL 603429

AUTO-TILTING TARGETS 603430

TUMBLING TARGET 603421

LARGE STICKY TARGET 603406

50 PAPER TARGETS 603490

50 CARDBOARD TARGETS 603420

10 SPLASH 8" TARGETS 268014

10 SPLASH 12" TARGETS 268015

**STROBE MARKER LIGHTS**



- R 263974
- G 263975
- B 263976
- O 263977
- Y 263978
- P 263979
- W 263980
- IR 263981





**MOLLE RIGS**  
TRIPLE MAG PANEL NOT INCLUDED

BLACK  
604271



COYOTE  
604272

OD  
604273

GREY  
604274

**TRIPLE MAG PANELS**



BLACK  
604275

COYOTE  
604276

OD  
604277

GREY  
604278



BLACK  
604268



OD  
604269



TAN  
604270

**HEAVY VESTS**



BLACK  
604029



OD  
604030



BLACK  
604034

**WARRIOR & MOLLE VESTS**



604065 (BLACK)  
604063 (TAN)



604054 (BLACK)  
604051 (OD)

**CRS TACTICAL VESTS**



BLACK  
604225



OD  
604226



TAN  
604227



ATP  
604228

**GPB**  
Dummy plates included  
Plaques factices incluses  
Placas ficticias incluidas



BLACK  
604528



OD  
604529



TAN  
604530



ATP  
604531

**COBRA STALKER**  
Balaclava style with grided protective mask  
Masque de protection grillagé avec cagoule  
Máscara de malla protectora con capucha



BLACK  
604229



OD  
604230



TAN  
604231



ATP  
604232

**MINI RIG**  
Light weight tactical vest  
Harnais tactique léger  
Arnés táctico ligero



BLACK  
604532



OD  
604533



TAN  
604534



ATP  
604535

**STALKER EVO**  
Grided protective mask  
Masque de protection grillagé  
Máscara de malla protectora



**1 POINT - PARACORD SLINGS**



**2 POINTS - PARACORD SLINGS**



**SLINGS**



**SHOTGUN ACCESSORIES**



**PROTECT YOUR EYES!**

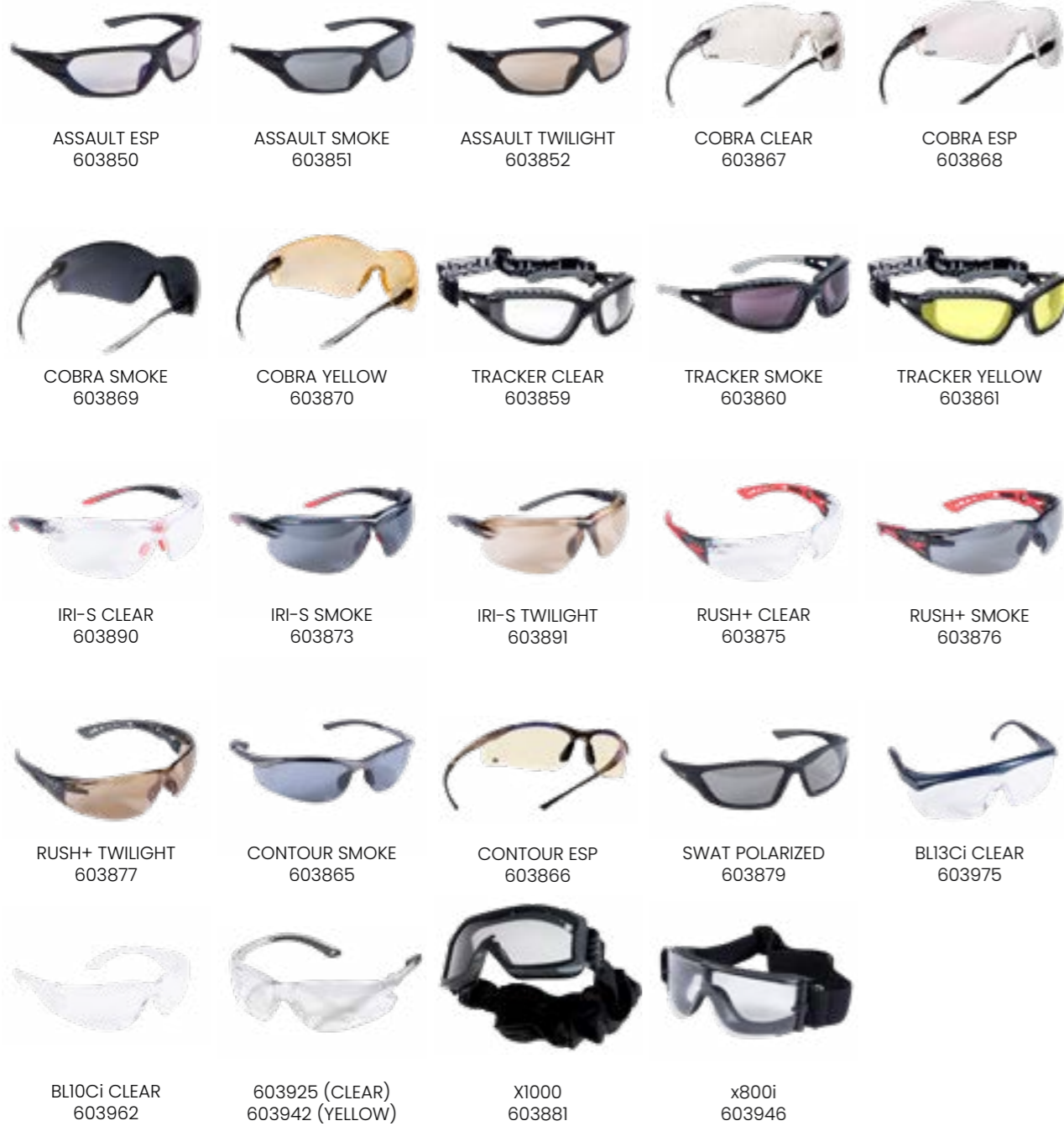

**ANTI-FOG SPRAY**



ANTI-FOG SPRAY  
603746

**SHOULDER & LEG HOLSTERS**



BLACK  
603612



BLACK  
603623



BLACK  
603603



LEG PLATFORM  
603661

**BELT HOLSTERS**



MULTI-ANGLES  
603614



AMBIDEXTROUS  
603616



BLACK  
603611



TAN  
603670



OD  
603671



COLT 1911  
603656



CYBERGUN PT92  
603654



SWISS ARMS NAVY PISTOLS  
603655



TYPE 17  
603668



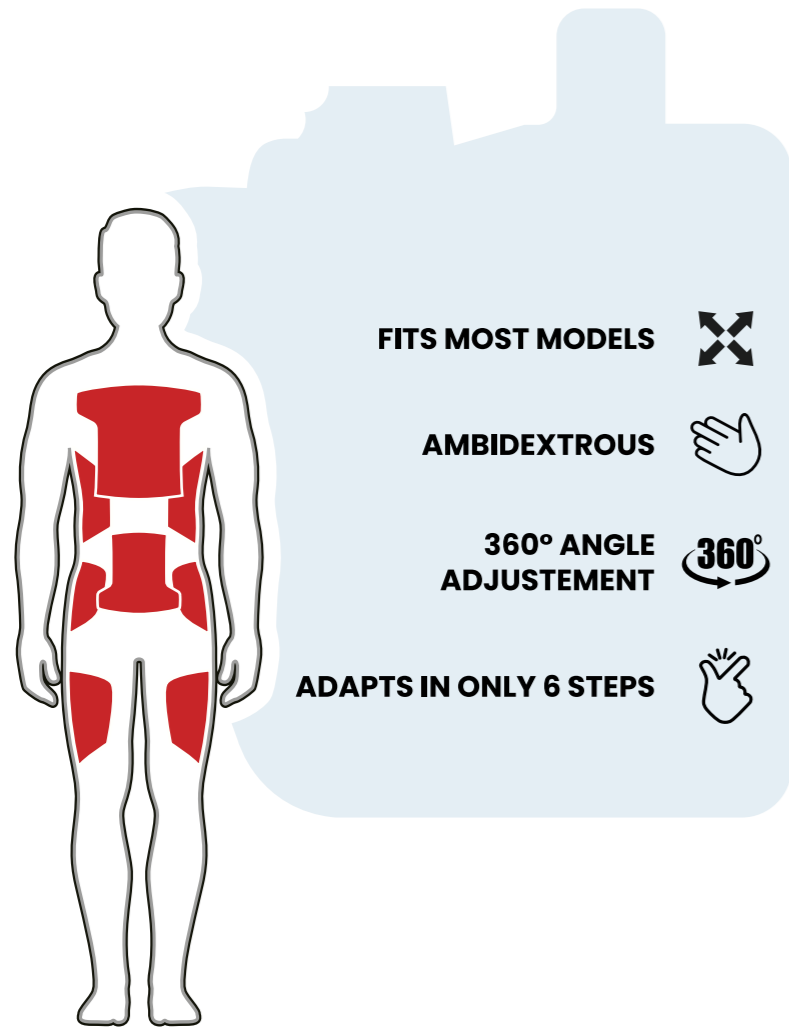

FITS MOST MODELS

AMBIDEXTROUS

360° ANGLE ADJUSTEMENT

ADAPTS IN ONLY 6 STEPS

LEVEL 2



BLACK  
603659



OD  
603812



TAN  
603813



GREY  
603814

RETENTION

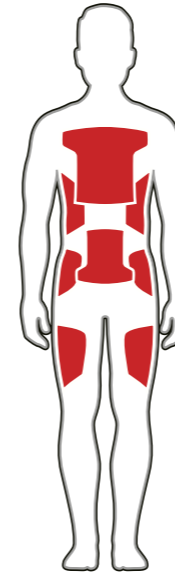

LEVEL 3



BLACK  
603694



OD  
603695



TAN  
603696



PINK  
603697



BLUE  
603698



GREY  
603699

RETENTION

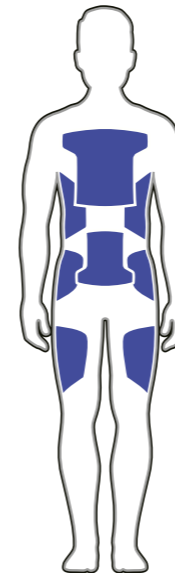

**DOUBLE RETENTION**  
STANDARD DES FORCES DE L'ORDRE  
LAW ENFORCEMENT STANDARD

Circular extension & holster depressor included  
Extension circulaire & abaisseur de holster inclus  
Extensión circular y depresor de funda incluidos

+ RETENTION KIT  
603815



**FAST M4 & AK TYPE**



BLACK  
604237



BLACK & RED  
604264



BLACK & TAN  
604263



GREY  
604240



OD  
604239



TAN  
604238



BLACK  
604241



BLACK & RED  
604266



BLACK & TAN  
604265



GREY  
604244



OD  
604243



TAN  
604242

**9 mm TYPE**



BLACK  
604233



GREY  
604236



OD  
604235



TAN  
604234

**FAST TYPE**



BLACK  
604245



BLACK & ATP  
604250



ATP  
604249



GREY  
604248



OD  
604247

**1911 TYPE**



TAN  
604246



**M4 & AK TYPE**



BLACK  
604251



BLACK & ATP  
604255



ATP  
604256



GREY  
604254



OD  
604253



TAN  
604252

**M4/AK & 9 mm TYPE**



BLACK  
604257



BLACK & ATP  
604262



ATP  
604261



GREY  
604260



OD  
604259



TAN  
604258

**GUN CASES & BAGS**



24 x 16 x 5 cm  
MAL1



27 x 17 x 6 cm  
MAL2



29 x 18 x 5 cm  
MAL3



122 x 25 x 10 cm  
MAL8



31 x 20 x 6.5 cm  
MAL10



120 cm  
604154



120 cm  
604157



85 x 28 x 5.5 cm  
604061



98 x 30 x 7 cm  
604060



30 x 2.5 x 2.3 cm  
604055



SMALL 10L  
604285 (BLACK)  
604286 (COYOTE)



OPS 35L  
604287 (BLACK)  
604288 (COYOTE)  
604289 (GREY)



MOLLE 40L  
604290 (BLACK)  
604291 (COYOTE)  
604292 (GREY)



91 cm  
604279 (BLACK)  
604280 (COYOTE)  
604281 (GREY)



107 cm  
604282 (BLACK)  
604283 (COYOTE)  
604284 (GREY)



100 x 30 x 8 cm  
604005



120 x 30 x 8 cm  
604006

**MOUNTS & RAILS**



AK RAIL  
268009

FAMAS RAIL  
403001

M16 RAIL  
605204

45° RAIL  
605271

PISTOL RAIL  
605222

M4/M16 HANDGUARD  
605212

25,4 or 30 mm  
605234

M4/M16 FLIP REAR SIGHT  
183161

QD SLING MOUNT  
603646

QD SLING MOUNT  
603647

AK SIDE MOUNT  
123001

AK SCOPE MOUNT  
123002

**BIPODS**



240 mm  
605262

215-290 mm  
605311

175-245 mm  
605298

190-228 mm (M-LOK)  
605299

160-230 mm  
605224

BLACK  
605264

260-335 mm  
605246

**SILENCERS**



147 x 32 mm  
605231 (CW/CCW)

110mm x 30 mm  
605232 (CW/CCW)

200mm x 45 mm  
605260 (CCW)

120mm x 45 mm  
605259 (CCW)

192 x 35 mm  
605249 (CCW)

200 x 40 mm - SCAR-H  
605285

180 x 35 mm  
605251 (CCW)

180 x 35 mm - M4  
605236 (CCW)

60 x 32 mm  
605233 (CCW)

213 x 40 mm  
605230 (CCW)

SPITFIRE TRACER  
605297 (CCW)

FN SCAR®-L  
605286

**ADAPTERS**



FN SPR ADAPTER  
203004 (CCW)

FNX-45 ADAPTER  
605277 (CCW)

COLT ANNIVERSARY 1911  
605281 (CCW)

SPEED REDUCER  
605252 (CCW)

AMPLIFIER  
605240 (CCW)

CW & CCW : CLOCKWISE & COUNTERCLOCKWISE / HORAIRE & ANTIHORAIRE / HORARIO & ANTIHORARIO

**GRIPS**



BLACK (M-LOK)  
605294

BLUE (M-LOK)  
605295

RED (M-LOK)  
605296

TAN - 605267  
BLACK - 605268

BLACK  
605261



**SCOPES**



**DOT SIGHTS**



LASERS



263983



263984



263985



263986



263987



263988



263989



263990



263877

FLASHLIGHTS



WHITE  
263862



GREEN  
263926



WHITE  
263927



FITS ON 263926-27

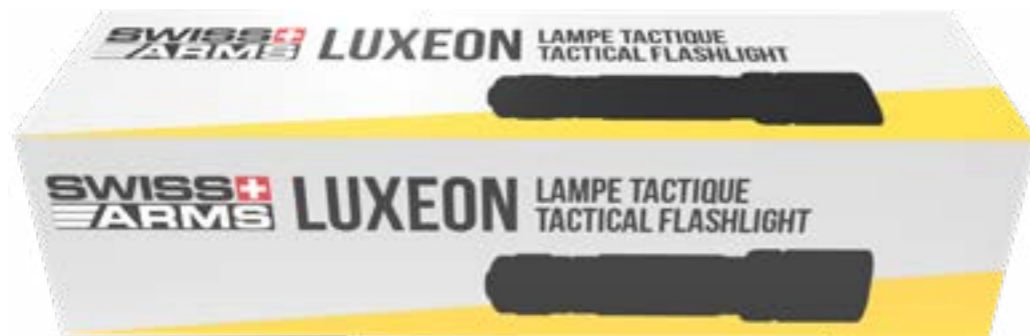

COLLECTION FOR 1911!



AIRBORNE  
603732



EAGLE  
603734



STAR  
603735



BOMBARDIER  
603736



US FLAG  
603737



VIKING RUNES  
603738



TRIANGLES  
603739



WILD LIFE  
603747



FLOWERS  
603741

PEARL HARBOR  
★ ★ ★ ★ ★  
REMEMBRANCE  
DAY 80<sup>TH</sup>  
ANNIVERSARY



\*CHECK ON OUR WEBSITE FOR OTHER LIMITED EDITIONS





# INTERACTIVE GUN PRACTICE

An interactive and mobile target system which allows you to train with your 6 mm replicas.



24"  
603438

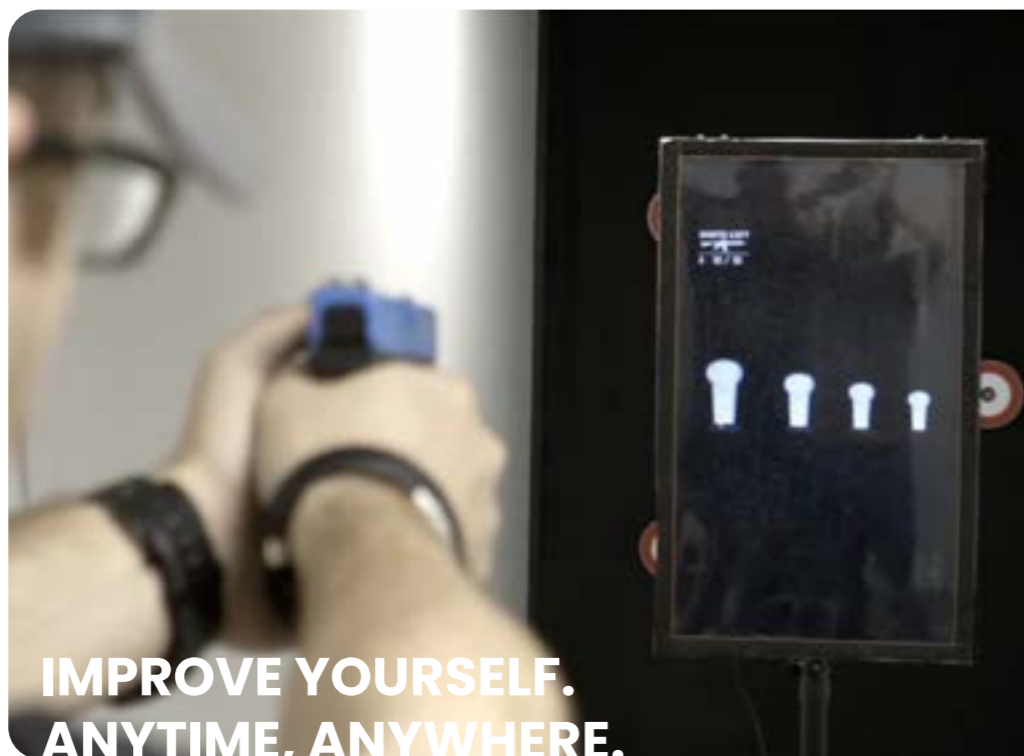

**IMPROVE YOURSELF.  
ANYTIME, ANYWHERE.**

Un système de cible interactive et mobile qui vous permet de vous entraîner avec vos répliques 6 mm.



49"  
603423



**AMÉLIOREZ-VOUS.  
N'IMPORTE QUAND, N'IMPORTE OÙ.**



# CONNECTED TARGET BADA BANG

## CONNECTED TARGET BADA BANG



BB-TARGET01

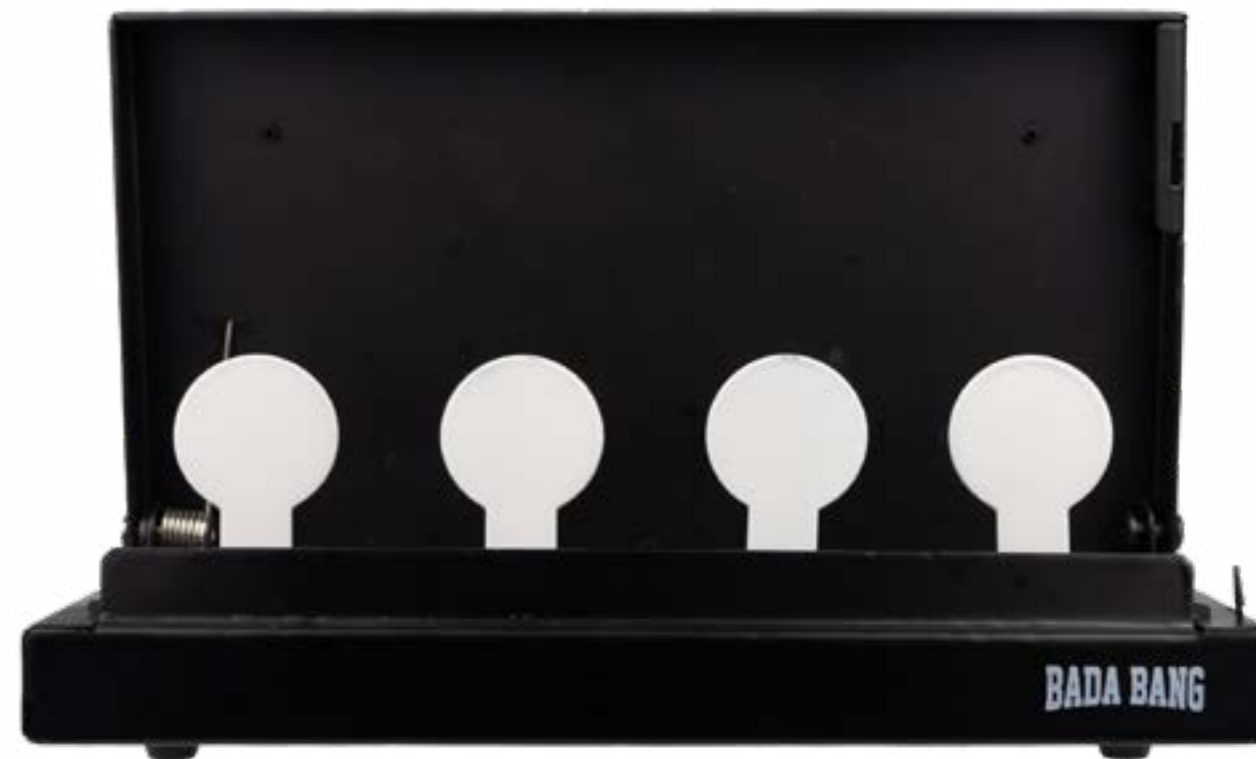

ONLY WITH STEEL BBs / SEULEMENT AVEC DES BILLES D'ACIER / SÓLO CON BOLAS DE ACERO





# AIRGUN

REPLICAS - ACCESSORIES





# AIRGUN COLLECTION

**CANiK TP9 ELITE COMBAT (1.7 J)**

558001 (BLACK) / 558002 (TAN) / 558003 (DUAL TONE)



NEW

- 633505
- 633510
- + 558004

4.5 mm .177 CO<sub>2</sub> BLOW BACK METAL SLIDE **CANiK** SUPERIOR FIREARMS

**DESERT EAGLE L6 .50AE (2 J)**

958502



NEW

- 633505
- 633510

4.5 mm .177 CO<sub>2</sub> BLOW BACK METAL SLIDE **DESERT EAGLE**

**DESERT EAGLE .50AE (2 J)**

958501



NEW

- 633505
- 633510

4.5 mm .177 CO<sub>2</sub> BLOW BACK METAL SLIDE **DESERT EAGLE**

**CANiK SFX RIVAL (1.7 J)**

558005 (BLACK) / 558006 (DUAL TONE) / 558007 (GREY)



NEW

- 633505
- 633510
- + 955004

4.5 mm .177 CO<sub>2</sub> BLOW BACK METAL SLIDE **CANiK** SUPERIOR FIREARMS

**BABY EAGLE (2.8 J)**

958301 (BLACK) / 958302 (SILVER) / 958303 (DUAL TONE)



- 633505
- 633510
- + 955004

4.5 mm .177 CO<sub>2</sub> NBB METAL SLIDE **DESERT EAGLE**

**FN 509® CIVILIAN**

208500 (BLACK) / 208502 (FDE) / 208503 (DUAL TONE)



NEW

- 633505
- 633510

4.5 mm .177 CO<sub>2</sub> BLOW BACK METAL SLIDE **FN HERSTAL**

# AIRGUN COLLECTION



**FN M4 A1 (4 J)**

208300



- 633505
- 633510
- + 288081



**FN HERSTAL**

4.5 mm .177 CO<sub>2</sub> FULL METAL

**FN M4-03 (3.7 J)**

208301



- 633505
- 633510
- + 288081



**FN HERSTAL**

4.5 mm .177 CO<sub>2</sub> FULL METAL

**FN M4-05 (3.7 J)**

208302



- 633505
- 633510
- + 288081



**FN HERSTAL**

4.5 mm .177 CO<sub>2</sub> FULL METAL



# AIRGUN COLLECTION

**KALASHNIKOV AK74 (4.3 J)**  
128302



633505  
633510

128802 **KALASHNIKOV**



**KALASHNIKOV AK101 (4.3 J)**  
128303



633505  
633510

128802 **KALASHNIKOV**



**KALASHNIKOV AKS74U (3.5 J)**  
128304



633505  
633510

128802 **KALASHNIKOV**



**KALASHNIKOV AK47 (2.2 J)**  
128300



633505  
633510

128800 **KALASHNIKOV**



# AIRGUN COLLECTION



**SPRINGFIELD ARMORY XD-M® 3.8" (1.8 J)**  
SA-XDM38CBB4-BE



633505  
633510

SA-XDMCO2BB4-MBE



**SPRINGFIELD ARMORY XD-M® 3.8" (1.8 J)**  
SA-XDM38CBB4-SBE



633505  
633510

SA-XDMCO2BB4-MBE



**SPRINGFIELD ARMORY XD-M® 4.5" (1.8 J)**  
SA-XDM45CBB4-BE



633505  
633510

SA-XDMCO2BB4-MBE



**SPRINGFIELD ARMORY XD-M® 4.5" (1.8 J)**  
SA-XDM45CBB4-SBE



633505  
633510

SA-XDMCO2BB4-MBE



**SPRINGFIELD ARMORY XD-E™ 4.5" (1.8 J)**  
SA-XDE45BB-BE



633505  
633510

SA-XDE45BB-ME



**SWISS ARMS PROTECTOR (2.1 J)**  
288075 (BLACK) / 288076 (TAN)



633505  
633510

288809



**NEW**





# AIRGUN COLLECTION

**SWISS ARMS X FN HERSTAL M4 RAS (3.9 J)**  
288072 (BLACK) / 288073 (TAN)



✓ 633505  
633510  
+ 288081



**SWISS ARMS P84 (2 J)**  
288707 (BLACK) / 288763 (TAN)



✓ 633505  
633510  
+ 288812



**SWISS ARMS P92 (1.6 J)**  
288709



✓ 633505  
633510  
+ 288810



**SWISS ARMS P92 STAINLESS (1.6 J)**  
288511



✓ 633505  
633510  
+ 288810



**SWISS ARMS SA92 (2.1 J)**  
288026 (NYLON FIBER) / 288028 (METAL)



✓ 633505  
633510  
+ 288825



**SWISS ARMS P1911 (1.7 J)**  
288710



✓ 633505  
633510  
+ 288815



**SWISS ARMS 1911 TACTICAL (1.6 J)**  
288508



✓ 633505  
633510  
+ 288815



**SWISS ARMS 1911 SEVENTIES STAINLESS (1.6 J)**  
288509



✓ 633505  
633510  
+ 288815



**SWISS ARMS P1911 MATCH (2.2 J)**  
288708 (BLACK) / 288764 (TAN)



✓ 633505  
633510  
+ 288812



**SWISS ARMS 1911 MILITARY RAIL (1.6 J)**  
288507 (TAN) / 288513 (BLACK)



✓ 633505  
633510  
+ 288815



**SWISS ARMS SA24 (2.6 J)**  
288308



✓ 633505  
633510  
+ 288824



# AIRGUN COLLECTION



# AIRGUN COLLECTION

### SWISS ARMS RAVEN (10 J & 13.5 J)

288064 (NO SAFETY) / 288065 (10 J) & 288066 (NO SAFETY) / 288067 (13.5 J) (4.5 mm)  
288068 (NO SAFETY) / 288069 (10 J) & 288070 (NO SAFETY) / 288071 (13.5 J) (5.5 mm)



### SWISS ARMS CROW (10 J)

288084 / 288085 (WITH SCOPE) (4.5 mm)  
288086 / 288087 (WITH SCOPE) (5.5 mm)



### SWISS ARMS CONDOR (19.5 J)

288088 / 288089 (WITH SCOPE) (4.5 mm)  
288090 / 288091 (WITH SCOPE) (5.5 mm)



### SWISS ARMS CARBINE (19.5 J)

288757



# AIRGUN COLLECTION

### SWISS ARMS NRG (19.9 J)

288103 (BLACK) / 288104 (TAN) / 288105 (WHITE)



### SWISS ARMS TG1 NITROgen PISTON (19.9 J)

288796 (GREY-BLUE)



### SWISS ARMS TG1 NITROgen PISTON (19.9 J)

288797 (BLUE) / 288799 (GREEN) / 288798 (RED)



### SWISS ARMS TG1 (19.5 J)

288739 (BLACK) / 288735 (TAN) (4.5 mm)  
288742 (BLACK) / 288743 (TAN) (5.5 mm)







# AIRGUN COLLECTION

**SWISS ARMS TAC1 NITROgen PISTON (19.9 J)**  
288792



**SWISS ARMS TAC1 NITROgen PISTON (19.9 J)**  
288793 (BLUE) / 288795 (GREEN)



**SWISS ARMS TAC1 NITROgen PISTON (19.9 J)**  
288794 (RED)



**SWISS ARMS TAC1 (19.5 J)**  
288732 (BLACK) / 288731 (TAN) (4.5 mm)  
288728 (BLACK) / 288729 (TAN) (5.5 mm)



# AIRGUN COLLECTION

**SWISS ARMS SPARROW (4.5 J)**  
288082 (4.5 mm) / 288083 (5.5 mm)



**TANFOGLIO GOLD CUSTOM (1.5 J)**  
358013



**TANFOGLIO LIMITED CUSTOM (1.5 J)**  
358014

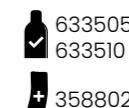

**AUTO-ORDNANCE 1911 (3 J)**  
438301 (METAL SLIDE) / 438302 (FULL METAL)

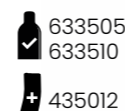

**THOMPSON 1911 (3 J)**  
438305



**PELLETS & BBs**



**SHOOTING MATS**

Light weight shooting mats  
Tapis de tir léger  
Alfombra de tiro ligera



**MOUNTS & RAILS**



**MAINTENANCE**





**SCOPES**



**DOT SIGHTS**



# WARNING

ATTENTION - ATENCIÓN

## DÉCRET

### Décret n° 99-240 du 24 mars 1999 relatif aux conditions de commercialisation de certains objets ayant l'apparence d'une arme à feu.

Sur le rapport du garde des sceaux, ministre de la justice, du ministre de l'intérieur, du ministre de la défense et du ministre de l'économie, des finances et de l'industrie, Vu la directive 98/34/CE du Parlement européen et du Conseil du 22 juin 1998 prévoyant des normes et des règles techniques, et la lettre parvenue le 28 mai 1997 à la Commission des Communautés européennes par laquelle le Gouvernement français a saisi ladite commission ; Vu le code pénal, notamment ses articles 121-2, 131-41 et R. 610-1 ; Vu le code de la consommation, et notamment son article L. 221-3 ; Vu l'avis de la commission de la sécurité des consommateurs en date du 2 juillet 1997 ; Le Conseil d'Etat (section des finances) entendu, Décrète :

Art. 1er. - L'offre, la mise en vente, la vente, la distribution à titre gratuit ou la mise à disposition à titre onéreux ou gratuit des objets neufs ou d'occasion ayant l'apparence d'une arme à feu, destinés à lancer des projectiles rigides, lorsqu'ils développent à la bouche une énergie supérieure à 0,08 joule et inférieure ou égale à 2 joules, sont réglementées dans les conditions définies par le présent décret.

Art. 2. - La vente, la distribution à titre gratuit à des mineurs ou la mise à leur disposition à titre onéreux ou gratuit des produits visés à l'article 1er du présent décret sont interdites.

Art. 3. - L'indication de l'énergie exprimée en joules développée par les produits visés à l'article 1er du présent décret doit figurer à la fois sur le produit, sur son emballage et sur la notice d'emploi obligatoirement jointe.

Art. 4. - L'emballage ainsi que la notice d'emploi des produits visés à l'article 1er du présent décret doivent indiquer, en caractères lisibles, visibles et indélébiles, les deux mentions : « Distribution interdite aux mineurs » et « Attention : ne jamais diriger le tir vers une personne ».

Art. 5. - Est puni de la peine d'amende prévue pour les contraventions de la 5e classe :

1° Le fait de vendre, de distribuer à titre gratuit à des mineurs, de mettre à leur disposition à titre gratuit ou onéreux les produits visés à l'article 1er du présent décret ;

2° Le fait d'offrir à la vente, de mettre en vente, de vendre, de distribuer à titre gratuit, de mettre à disposition à titre gratuit ou onéreux les produits visés à l'article 1er du présent décret en méconnaissant les dispositions des articles 3 et 4 du présent décret.

En cas de récidive, la peine d'amende prévue pour la récidive de la contravention de 5e classe est applicable. Les personnes morales peuvent être déclarées pénalement responsables, dans les conditions prévues à l'article 121-2 du code pénal, des infractions définies au présent article ; elles encourent la peine d'amende selon les modalités prévues à l'article 131-41 du même code.

Art. 6. - Le garde des sceaux, ministre de la justice, le ministre de l'intérieur, le ministre de l'économie, des finances et de l'industrie, le ministre de la défense, la secrétaire d'Etat aux petites et moyennes entreprises, au commerce et à l'artisanat et le secrétaire d'Etat à l'industrie sont chargés, chacun en ce qui le concerne, de l'exécution du présent décret, qui sera publié au Journal officiel de la République française.

Fait à Paris, le 24 mars 1999.  
Par le Premier ministre :  
LIONEL JOSPIN

# COUNTERFEITING

CONTREFAÇON - FALSIFICACIÓN

#### CRIMINAL AND CUSTOMS PENALTIES FOR COUNTERFEITING

Any use of the trademarks owned by or licensed to CYBERGUN without the prior authorization of CYBERGUN shall be considered an act of counterfeiting.

Similarly, Council Regulation (EG) No 241 of January 25, 1999 extended the scope of Customs action from strictly counterfeit goods to pirated goods.

This means all goods that are or embody copies made without the consent of the holder of the copyright or neighbouring rights, or the holder of a design right or model right. Action against the marketing of allegedly counterfeit goods and pirated goods is taken by both the competition and fraud repression and the general directorate of customs and indirect rights.

Penalties for acts of counterfeiting or the importation, exportation or production, are provided for in Law No. 94102 of February 5, 1994 amended by Law No. 2004-204 of March 9, 2004, which substantially raised the level of the criminal penalties provided for in Article L.716-9 of the Code of Intellectual Property Law. Henceforth, the counterfeiting of any intellectual property rights and therefore trademarks is punishable by 4 years imprisonment and a fine of 400,000€. When the crimes defined in Article L.716-9 of the Code of Intellectual Property Law are committed in organised groups, the penalties are raised to 5 years imprisonment and a fine of 500,000€.

Article L. 716-10 of the Code of Intellectual Property Law, amended by Law No. 2004-204 of March 9, 2004 provides for a term of three years imprisonment and a 300,000€ fine for the possession and/or sale of counterfeit goods and the reproduction or use of a counterfeit trademark.

All of the penalties stipulated in Articles L.716-9 to L.716 -10 are doubled in the event of a second offence.

Under criminal law, these penalties are applicable to directors, in law or in fact, of companies whose business activity has been recognised and qualified as counterfeiting. Furthermore, this crime can also be the responsibility of legal persons. Given that the French Code of Intellectual Property Law is subject to the provisions of the New Code of Criminal Law, the result is that the fine incurred by an entity can be as high as 2,000,000€ or 2,500,000€ depending on the case an whether the entity can also be punished by various prohibition measures or even dissolution. Furthermore, importation or exportation of allegedly counterfeit goods and pirated goods is now a customs offence.

The Law of February 5, 1994 led to a corresponding modification of Article 428 of the Code of Customs Regulations, enabling the import or export of goods, presented under a counterfeit trademark, to be punished by the penalties applicable to customs offences, as provided for in the Code of Customs Regulations.

These offences are punishable by Article 414, which provides that the import or export, without a declaration, of counterfeit trademarked goods is punishable by:

- a maximum of 3 years imprisonment.
- confiscation of the object of fraud.
- confiscation of the means of transport.
- confiscation of the objects used to mask the fraud.
- a fine of between one and two times the value of the object of fraud.

Article 432 bis of the Code of Customs Regulations provides, as an additional penalty, that the court may also decree:

- Temporary prohibition to conduct whatsoever business activity;
- Driving licence suspension (duration of suspension not to exceed 3 years).

These penalties provided for in the Code of Customs Regulations are in addition to those provided for by Article L.716-9 of the Code of Intellectual Property Law (4 or 5 years imprisonment and € 400,000 or € 500,000 in fines). Lastly, it must be stated that the directors of companies prosecuted as a result of breaches of laws and regulations designed to fight against the import, export or marketing of goods presented under a counterfeit trademark are personally liable for the fines and customs penalties incurred, in addition to any possible prison sentences.

Within this context, and in order to defend its rights, that CYBERGUN has already undertaken several legal actions for counterfeiting.

Jacques LOISEAU Lawyer at the Essonne Bar Specialist in Company Law - Diploma from the National Customs School

#### SANCTIONS PENALES ET DOUANIERES DES ACTES DE CONTREFAÇON

Tout acte d'utilisation des marques et modèles appartenant ou concédées à CYBERGUN, considérées comme marques d'autrui, sans autorisation préalable de la société GYBERGUN est considéré comme un acte de contrefaçon.

De la même manière, le règlement (CE) n° 241/1999 du Conseil de l'Union Européenne du 25 janvier 1999 a étendu le domaine du délit douanier de la stricte marchandise de contrefaçon à la "marchandise pirate". Il s'agit de tous produits qui sont ou qui contiennent des copies fabriquées sans le consentement du propriétaire du droit d'auteur, d'un droit relatif au dessin ou au modèle.

La commercialisation de marchandises contrefaites et de marchandises pirates est contrôlée et réprimée respectivement par la direction Générale de la concurrence et de la répression des fraudes et la direction générale des douanes et des droits indirects. La répression des actes de contrefaçon pour importation, exportation ou production, est prévue par la loi n° 94-102 du 5 février 1994 modifiée par la loi n° 2004-204 du 9 mars 2004, qui a considérablement élevé le niveau des sanctions pénales prévues à l'article L.716-9 du Code de la propriété intellectuelle.

Désormais, la contrefaçon de tout droit de propriété intellectuelle est punie d'un emprisonnement de 4 ans et d'une amende de 400.000€. Lorsque les délits prévus à l'article L.716- 9 du Code de la propriété intellectuelle ont été commis en bande organisée, les peines sont portées à 5 ans d'emprisonnement et 500.000€ d'amende.

L'article L. 716-10 du Code de la propriété intellectuelle modifié par la loi n° 2004-204 du 9 mars 2004 réprime de 3 ans d'emprisonnement et de 300.000€ d'amende les faits de détention, de vente de produits contrefaits et le fait de reproduire ou d'utiliser une marque contrefaite.

L'ensemble de ces peines reprises aux articles L.716-9 et L.716-10 sont portées au double en cas de récidive.

Selon la loi pénale, ces sanctions sont applicables aux dirigeants de droit ou de fait des sociétés dont l'activité commerciale a été reconnue et qualifiée de contrefaçon. Par ailleurs, ce délit peut engager la responsabilité des personnes morales. Le Code de Propriété intellectuelle renvoyant aux dispositions du code Pénal, il en résulte que l'amende encourue par la personne morale s'élève à 2.000.000€ ou 2.500.000€ selon le cas et que la personne morale peut en outre être sanctionnée par des mesures d'interdiction diverses ou même de dissolution. Par ailleurs, l'importation ou l'exportation de marchandises réputées contrefaites et de marchandises pirates est devenue un délit douanier.

D'autre part, la loi du 5 février 1994 a entraîné la modification corrélative de l'article 428 du code des Douanes qui permet de sanctionner l'importation ou l'exportation de marchandises présentées sous une marque contrefaite des peines applicables aux délits douaniers prévus au code des Douanes.

Ces délits sont réprimés par l'article 414 qui prévoit que la contrebande comme l'importation ou l'exportation sans déclaration de marchandises de contrefaçon de marques est possible :

- d'un emprisonnement maximum de 3 ans.
- de la confiscation de l'objet de fraude.
- de la confiscation des moyens de transport.
- de la confiscation des objets ayant servi à masques la fraude.

- d'une amende comprise entre une et deux fois la valeur de l'objet de fraude.

L'article 432 bis du code des Douanes prévoit, à titre de peine complémentaire;

- l'interdiction temporaire d'exercer toute profession industrielle, commerciale ou libérale;
- la suspension du permis de conduire un véhicule automobile (la durée de suspension ne peut excéder 3 ans).

Ces sanctions prévues par le code des Douanes sont par ailleurs cumulables avec celles prévues par l'article L.716-9 du Code de la propriété intellectuelle (4 ou 5 ans d'emprisonnement et 400.000€ ou 500.000€ d'amende). Il convient enfin de préciser que les dirigeants des sociétés poursuivies à la suite d'infraction à la réglementation sur la répression de l'importation ou l'exportation ou la commercialisation des marchandises présentées sous une marque contrefaite sont personnellement responsables des amendes pénales et pénalités douanières encourues, outre les éventuelles condamnations à un emprisonnement.

C'est dans ce cadre et pour la défense de ses droits que la société CYBERGUN a d'ores et déjà engagé plusieurs actions en contrefaçon.

Jacques LOISEAU Avocat au Barreau de l'Essonne Spécialiste en Droit des Sociétés - Diplôme de l'École Nationale des Douanes

#### SANCIONES PENALES Y ADUANERAS DE LOS ACTOS DE FALSIFICACIÓN

Así pues, el uso de cualquiera marcas perteneciente o licenciadas a CYBERGUN, consideradas como marcas de terceros, sin previa autorización de la sociedad CYBERGUN, será considerado un acto de falsificación. Del mismo modo, el Reglamento (CE) n° 241/1999 del Consejo de la Unión Europea de 25 de enero de 1999 amplió el ámbito del delito aduanero de la mercancía estrictamente falsificada a las mercancías piratas. Se trata de cualquier producto que sea o contenga copias fabricadas sin el consentimiento del propietario del derecho de autor a de un derecho relativo al diseño o al modelo. La comercialización de mercancías consideradas falsificadas o piratas está controlada y es castigada por la Dirección General de la Competencia, del Consumo y de la Represión de Fraudes y por la Dirección General de Aduanas y Derechos indirectos, respectivamente. La ley n° 94102 de 5 de febrero de 1994, modificada por la ley n° 2004-204 de 9 de marzo de 2004, prevé el castigo de los actos de falsificación para la importación, exportación o producción, y electo considerablemente el nivel de las sanciones previstas en el artículo L. 716-9 del Código de la Propiedad intelectual.

A partir de ese momento, la falsificación de cualquier derecho de propiedad intelectual y, por tanto, de una marca está penada con 4 años de prisión y una multa de 400.000€. Cuando los delitos previstos en el artículo L.716-9 del Código de la Propiedad intelectual los comete una banda organizada, las penas se incrementan a 5 años de prisión y 500.000€ de multa.

El artículo L.716-10 del Código de la Propiedad intelectual, modificado por la ley n° 2004-204 de 9 de marzo de 2004, castiga con 3 años de prisión y 300.000€ de multa la tenencia y la venta de productos falsificados, así como el hecho de reproducir o utilizar una marca falsificada. Todas estas penas recogidas en los artículos L.716-9 y L.716-10 sé elevan al doble en caso de reincidencia.

Según la ley penal, estas sanciones se aplican a los dirigentes, de derecho o de hecho, de las sociedades cuya actividad comercial haya sido considerada como o calificada de falsificación. Por otra parte, este delito puede acarrear la responsabilidad de personas jurídicas. Dado que el Código de la Propiedad intelectual remite a las disposiciones del Código Penal, la multa incurrida por la persona jurídica se elevará a 2.000.000€ o 2.500.000€ en función del caso, y la persona jurídica puede ser además sancionada con diversas medidas de prohibición o incluso de disolución.

Asimismo, la importación o exportación de mercancías falsificadas o piratas se ha convertido en un delito aduanero. Por otra parte, la ley de 5 de febrero de 1994 ha provocado la modificación correlativa del artículo 428 del Código de Aduanas, que permite sancionar la importación o la exportación de mercancías presentadas bajo una marca falsificada con penas aplicables a los delitos aduaneros previstos en el Código de Aduanas.

Éstos delitos son castigados en virtud del artículo 414, que prevé que el contrabando, entendido como importación o exportación sin declaración de mercancías de falsificación de marcas, puede estar penado con:

- un máximo de 3 años de prisión.
- la confiscación del objeto de fraude.
- la confiscación de los medios de transporte.
- la confiscación de los objetos que hayan servido para ocultar el fraude.
- una multa equivalente a una o dos veces el valor del objeto de fraude.

El artículo 432 bis de Código de Aduanas prevé, como pena complementaria, que el Tribunal pueda establecer:

- la prohibición temporal de ejercer cualquier profesión industrial, comercial o liberal;
- la suspensión del permiso de conducir un automóvil (la duración de la suspensión no puede superar los 3 años).

Estas sanciones previstas por el Código de Aduanas son acumulables a las previstas por el artículo L.716-9 del Código de la Propiedad intelectual (4 a 5 años de prisión y 400.000€ o 500.000€ de multa). Por último, conviene precisar que los dirigentes de las sociedades procesadas tras una infracción de la reglamentación sobre la represión de la importación, la exportación o la comercialización de mercancías presentadas bajo una marca falsificada serán personalmente responsables de las sanciones penales y aduaneras correspondientes, así como de las posibles penas de prisión.

Por todo esto, y con el objetivo de proteger sus derechos, la sociedad CYBERGUN ya ha iniciado varias demandas de falsificación.

Jacques LOISEAU Abogado del Colegio de Abogados de Essonne Especialista en Derecho de Sociedades - Diploma de la Escuela Nacional de Aduanas



# LEGAL NOTICE

## MENTIONS LÉGALES - AVISO LEGAL



**EN:** ARSENAL FIREARMS and their logos are registered trademarks of Arsenal Firearms SRL Unipersonale and are used under exclusive worldwide license for AIRSOFT by CYBERGUN S.A..  
**FR:** Les marques déposées ARSENAL FIREARMS et leurs logos sont la propriété d'Arsenal Firearms SRL Unipersonale, et sont utilisés sous licence exclusive et mondiale pour l'AIRSOFT par CYBERGUN S.A..  
**ES:** ARSENAL FIREARMS y sus logotipos son marcas registradas de Arsenal Firearms SRL Unipersonale y se utilizan bajo licencia mundial exclusiva para AIRSOFT por CYBERGUN S.A..



**EN:** ARCHON FIREARMS is registered trademark of Dimitri Strechinski. CYBERGUN S.A. is a distributor of ARCHON FIREARMS licensed products.  
**FR:** La marque déposée ARCHON FIREARMS est la propriété de Dimitri Strechinski. CYBERGUN S.A. est distributeur des produits sous licence ARCHON FIREARMS.  
**ES:** ARCHON FIREARMS es una marca registrada de Dimitri Strechinski. CYBERGUN S.A. es un distribuidor de productos con licencia ARCHON FIREARMS.



**EN:** Pictures are not contractual. Products shown in this catalog may vary slightly, according to productions and continents, as well as mentioned features (velocity, power range, etc).  
**FR:** Photos non contractuelles. Les produits montrés dans ce catalogue peuvent varier très légèrement en fonction des productions et des continents, tout comme leurs caractéristiques techniques (vitesse, portée utile, etc).  
**ES:** Las imágenes no son contractuales. Los productos mostrados en este catálogo pueden variar ligeramente, según producciones y continentes, así como las características mencionadas (velocidad, alcance útil, etc).



**EN:** CANIK and their logos are registered trademarks of Samsun Yurt Savunma Sanayi ve Ticaret Anonim Şirketi and are used under exclusive worldwide license for AIRSOFT by CYBERGUN S.A..  
**FR:** Les marques déposées CANIK et leurs logos sont la propriété de Samsun Yurt Savunma Sanayi ve Ticaret Anonim Şirketi et sont utilisés sous licence exclusive et mondiale pour l'AIRSOFT par CYBERGUN S.A..  
**ES:** CANIK y sus logotipos son marcas registradas de Samsun Yurt Savunma Sanayi ve Ticaret Anonim Şirketi y se utilizan bajo licencia mundial exclusiva para AIRSOFT por CYBERGUN S.A..



**EN:** Century Arms and their logos are registered trademarks of Century Arms, and are used under exclusive worldwide license for AIRSOFT by CYBERGUN S.A..  
**FR:** Les marques déposées Century Arms et leurs logos sont la propriété de Century Arms et sont utilisés sous licence exclusive et mondiale pour l'AIRSOFT par CYBERGUN S.A..  
**ES:** Century Arms y sus logotipos son marcas registradas de Century Arms, y se utilizan bajo licencia mundial exclusiva para AIRSOFT por CYBERGUN S.A..



**EN:** COLT and the RAMPANT COLT logo are registered trademarks of NEW COLT HOLDING CORP., USA, «M4 is a registered trademark of COLT DEFENSE LLC, USA. Trademarks are used under exclusive worldwide license from NCHC for AIRSOFT by CYBERGUN S.A..  
**FR:** La marque déposée COLT et son logo sont la propriété de la NEW COLT HOLDING CORP., USA, «M4 est la propriété de COLT DEFENSE LLC, USA. Ces marques sont utilisées sous licence exclusive et mondiale pour l'airsoft par CYBERGUN S.A..  
**ES:** COLT y el logotipo de RAMPANT COLT son marcas registradas de NEW COLT HOLDING CORP., USA, «M4 es una marca registrada de COLT DEFENSE LLC, USA. Las marcas comerciales se utilizan bajo licencia mundial exclusiva de NCHC para AIRSOFT by CYBERGUN S.A..



**EN:** CYBERGUN® and the logo are registered trademarks by CYBERGUN S.A..  
**FR:** CYBERGUN® et le logo sont des marques déposées par CYBERGUN S.A..  
**ES:** CYBERGUN® y el logotipo son marcas registradas por CYBERGUN S.A..



**EN:** Pictures are not contractual. Products shown in this catalog may vary slightly, according to productions and continents, as well as mentioned features (velocity, power range, etc).  
**FR:** Photos non contractuelles. Les produits montrés dans ce catalogue peuvent varier très légèrement en fonction des productions et des continents, tout comme leurs caractéristiques techniques (vitesse, portée utile, etc).  
**ES:** Las imágenes no son contractuales. Los productos mostrados en este catálogo pueden variar ligeramente, según producciones y continentes, así como las características mencionadas (velocidad, alcance útil, etc).



**EN:** DESERT EAGLE and the logo are registered trademarks of MAGNUM RESEARCH, INC. These trademarks and the logo are used under worldwide exclusive license for AIRSOFT by CYBERGUN S.A.. Pictures are not contractual. Products shown in this catalog may vary slightly, according to productions and continents, as well as mentioned features (velocity, power range, etc).  
**FR:** DESERT EAGLE et le logo sont des marques déposées de MAGNUM RESEARCH, INC. Ces marques et logos sont utilisés sous licence exclusive mondiale pour l'AIRSOFT par CYBERGUN S.A.. Photos non contractuelles. Les produits montrés dans ce catalogue peuvent varier très légèrement en fonction des productions et des continents, tout comme leurs caractéristiques techniques (vitesse, portée utile, etc).  
**ES:** DESERT EAGLE y el logo son marcas registradas de MAGNUM RESEARCH, INC. Estas marcas y el logotipo son utilizados bajo licencia mundial exclusiva para AIRSOFT por CYBERGUN S.A. Las imágenes no son contractuales. Los productos mostrados en este catálogo pueden variar ligeramente, según producciones y continentes, así como las características mencionadas (velocidad, alcance útil, etc).



**EN:** DPMS and their logos are registered trademarks of Defense Procurement Manufacturing Services, Inc. and are used under exclusive worldwide license for AIRSOFT by CYBERGUN S.A..  
**FR:** Les marques déposées DPMS et leurs logos sont la propriété de Defense Procurement Manufacturing Services, Inc. et sont utilisés sous licence exclusive et mondiale pour l'AIRSOFT par CYBERGUN S.A..  
**ES:** DPMS y sus logotipos son marcas registradas de Defense Procurement Manufacturing Services, Inc. y se utilizan bajo licencia mundial exclusiva para AIRSOFT por CYBERGUN S.A..



**EN:** FAMAS is registered trademark of Nexter Systems (f.k.a GIAT INDUSTRIES), France, and is used under worldwide exclusive license for AIRSOFT by CYBERGUN S.A.. Pictures are not contractual. Products shown in this catalog may vary slightly, according to productions and continents, as well as mentioned features (velocity, power range, etc).  
**FR:** Ces marques sont utilisées sous licence exclusive et mondiale pour l'AIRSOFT par CYBERGUN S.A.. La marque déposée FAMAS et son logo sont la propriété de Nexter Systems (anciennement GIAT INDUSTRIES), France. Photos non contractuelles. Les produits montrés dans ce catalogue peuvent varier très légèrement en fonction des productions et des continents, tout comme leurs caractéristiques techniques (vitesse, portée utile, etc).  
**ES:** FAMAS es una marca registrada de Nexter Systems (f.k.a GIAT INDUSTRIES), Francia, y se utiliza bajo licencia mundial exclusiva para AIRSOFT por CYBERGUN S.A. Las imágenes no son contractuales. Los productos mostrados en este catálogo pueden variar ligeramente, según producciones y continentes, así como las características mencionadas (velocidad, alcance útil, etc).



**EN:** Firearms designs of FN SCAR®, FN P90®, FN F2000®, FN MINIMI®, FN® FAL FN®SPR, FN Five-seven®, FN® FN X-45 and related trademarks are the exclusive property of FN Herstal. CYBERGUN is the exclusive worldwide licensee of FN HERSTAL for AIRSOFT. Pictures are not contractual. Products shown in this catalog may vary slightly, according to productions and continents, as well as mentioned features (velocity, power range, etc).  
**FR:** Les designs des marques FN SCAR®, FN P90®, FN F2000®, FN MINIMI®, FN® FAL FN®SPR, FN Five-seven®, FN® FN X-45 et leur marques respectives sont la propriété exclusive de FN Herstal. Cybergun S.A. est le licencié exclusif et mondial de FN Herstal pour l'AIRSOFT. Photos non contractuelles. Les produits montrés dans ce catalogue peuvent varier très légèrement en fonction des productions et des continents, tout comme leurs caractéristiques techniques (vitesse, portée utile, etc).  
**ES:** Los diseños de las marcas FN SCAR®, FN P90®, FN F2000®, FN MINIMI®, FN® FAL FN®SPR, FN Five-seven®, FN® FN X-45 y sus respectivas marcas son propiedad exclusiva de FN Herstal. Cybergun S.A. es el licenciatario mundial exclusivo de FN Herstal para AIRSOFT. Las fotos no son contractuales. Los productos que aparecen en este catálogo pueden variar ligeramente según la producción y los continentes, así como sus características técnicas (velocidad, alcance útil, etc.).



**EN:** GSG and the logo are registered trademarks of GSG International and are used under worldwide exclusive license for AIRSOFT by CYBERGUN S.A.. Pictures are not contractual. Products shown in this catalog may vary slightly, according to productions and continents, as well as mentioned features (velocity, power range, etc).  
**FR:** La marque déposée GSG et son logo sont la propriété de GSG International. Ces marques sont utilisées sous licence exclusive mondiale pour l'AIRSOFT par CYBERGUN S.A.. Photos non contractuelles. Les produits montrés dans ce catalogue peuvent varier très légèrement en fonction des productions et des continents, tout comme leurs caractéristiques techniques (vitesse, portée utile, etc).  
**ES:** GSG y el logotipo son marcas registradas de GSG International y se utilizan bajo licencia mundial exclusiva para AIRSOFT por CYBERGUN S.A. Las imágenes no son contractuales. Los productos mostrados en este catálogo pueden variar ligeramente, según producciones y continentes, así como las características mencionadas (velocidad, alcance útil, etc).



**EN:** KAHR ARMS and their logos are registered trademarks of Saello Enterprises, INC, and are used under exclusive worldwide license for AIRSOFT by CYBERGUN S.A..  
**FR:** Les marques déposées KAHR ARMS et leurs logos sont la propriété de Saello Enterprises, INC, et sont utilisés sous licence exclusive et mondiale pour l'AIRSOFT par CYBERGUN S.A..  
**ES:** KAHR ARMS y sus logotipos son marcas registradas de Saello Enterprises, INC, y se utilizan bajo licencia mundial exclusiva para AIRSOFT por CYBERGUN S.A..



**EN:** KALASHNIKOV, Copyright Mikha'il Timofeievitch Kalashnikov, Izhevsk, Russian Federation, used under worldwide exclusive license for AIRSOFT by CYBERGUN S.A.. Pictures are not contractual. Products shown in this catalog may vary slightly, according to productions and continents, as well as mentioned features (velocity, power range, etc).  
**FR:** Les droits d'auteur et le nom de Mikhaïl Timofeievitch Kalashnikov, Izhevsk, Fédération de Russie, sont utilisés sous licence exclusive mondiale pour l'AIRSOFT par CYBERGUN S.A.. Photos non contractuelles. Les produits montrés dans ce catalogue peuvent varier très légèrement en fonction des productions et des continents, tout comme leurs caractéristiques techniques (vitesse, portée utile, etc).  
**ES:** KALASHNIKOV, Copyright Mikha'il Timofeievitch Kalashnikov, Izhevsk, Russian Federation, utilizado bajo licencia exclusiva mundial para AIRSOFT por CYBERGUN S.A. Las imágenes no son contractuales. Los productos mostrados en este catálogo pueden variar ligeramente, según producciones y continentes, así como las características mencionadas (velocidad, alcance útil, etc).



**EN:** MAUSER and their logos are registered trademarks of S.A.N., Switzerland, and are used under exclusive worldwide license for AIRSOFT by CYBERGUN S.A..  
**FR:** Les marques déposées MAUSER et leurs logos sont la propriété de S.A.N, Suisse, et sont utilisés sous licence exclusive et mondiale pour l'airsoft par CYBERGUN S.A..  
**ES:** MAUSER y sus logotipos son marcas registradas de S.A.N., Suiza, y se utilizan bajo licencia mundial exclusiva para AIRSOFT por CYBERGUN S.A..



**EN:** MOSSBERG and their logos are registered trademarks of Mossberg & Sons, Inc., North Haven and are used under exclusive worldwide license for AIRSOFT by CYBERGUN S.A..  
**FR:** Les marques déposées MOSSBERG et leurs logos sont la propriété de Mossberg & Sons, Inc., North Haven, et sont utilisés sous licence exclusive et mondiale pour l'AIRSOFT par CYBERGUN S.A..  
**ES:** MOSSBERG y sus logotipos son marcas registradas de Mossberg & Sons, Inc. de North Haven y se utilizan bajo licencia mundial exclusiva para AIRSOFT por CYBERGUN S.A..



**EN:** PGM Précision and their logos are registered trademarks of PGM Précision S.A. and are used under exclusive worldwide license for AIRSOFT by CYBERGUN S.A..  
**FR:** Les marques déposées PGM Précision et leurs logos sont la propriété de PGM Précision et sont utilisés sous licence exclusive et mondiale pour l'AIRSOFT par CYBERGUN S.A..  
**ES:** PGM Précision y sus logotipos son marcas registradas de PGM Précision S.A. y se utilizan bajo licencia mundial exclusiva para AIRSOFT por CYBERGUN S.A..



**EN:** SCHMEISSER and their logos are registered trademarks of Schmeisser International, and are used under exclusive worldwide license for AIRSOFT by CYBERGUN S.A..  
**FR:** Les marques déposées SCHMEISSER et leurs logos sont la propriété de Schmeisser International, et sont utilisés sous licence exclusive et mondiale pour l'AIRSOFT par CYBERGUN S.A..  
**ES:** SCHMEISSER y sus logotipos son marcas registradas de Schmeisser International, y se utilizan bajo licencia mundial exclusiva para AIRSOFT por CYBERGUN S.A..



**EN:** Shadow Systems and their logos are registered trademarks of Shadow Systems LLC, and are used under exclusive worldwide license for AIRSOFT by CYBERGUN S.A..  
**FR:** Les marques déposées Shadow Systems et leurs logos sont la propriété de Shadow Systems LLC, et sont utilisés sous licence exclusive et mondiale pour l'AIRSOFT par CYBERGUN S.A..  
**ES:** Shadow Systems y sus logotipos son marcas registradas de Shadow Systems LLC, y se utilizan bajo licencia mundial exclusiva para AIRSOFT por CYBERGUN S.A..



**EN:** SPRINGFIELD ARMORY and their logos are registered trademarks of Springfield Inc. CYBERGUN S.A. is a distributor of SPRINGFIELD ARMORY licensed products.  
**FR:** Les marques déposées SPRINGFIELD ARMORY et leurs logos sont la propriété de Springfield Inc. CYBERGUN S.A. est distributeur des produits sous licence SPRINGFIELD ARMORY.  
**ES:** SPRINGFIELD ARMORY y sus logotipos son marcas registradas de Springfield Inc. CYBERGUN S.A. es un distribuidor de productos con licencia de SPRINGFIELD ARMORY.



**EN:** SWISS ARMS® and the logo are registered trademarks for AIRSOFT by CYBERGUN S.A.. Pictures are not contractual. Products shown in this catalog may vary slightly, according to productions and continents, as well as mentioned features (velocity, power range, etc).  
**FR:** SWISS ARMS® et le logo sont des marques déposées pour l'AIRSOFT par CYBERGUN S.A.. Photos non contractuelles. Les produits montrés dans ce catalogue peuvent varier très légèrement en fonction des productions et des continents, tout comme leurs caractéristiques techniques (vitesse, portée utile, etc).  
**ES:** SWISS ARMS® y el logotipo son marcas registradas para AIRSOFT por CYBERGUN S.A. Las imágenes no son contractuales. Los productos mostrados en este catálogo pueden variar ligeramente, según producciones y continentes, así como las características mencionadas (velocidad, alcance útil, etc.).



**EN:** TANFOGLIO and their logos are registered trademarks of Fratelli Tanfoglio Snc, and are used under exclusive worldwide license for AIRSOFT by CYBERGUN S.A..  
**FR:** Les marques déposées TANFOGLIO et leurs logos sont la propriété de Fratelli Tanfoglio Snc, et sont utilisés sous licence exclusive et mondiale pour l'AIRSOFT par CYBERGUN S.A..  
**ES:** TANFOGLIO y sus logotipos son marcas registradas de Fratelli Tanfoglio Snc, y se utilizan bajo licencia mundial exclusiva para AIRSOFT por CYBERGUN S.A..



**EN:** THOMPSON & AUTO ORDNANCE and their logos are registered trademarks of Saello Enterprises, INC, and are used under exclusive worldwide license for AIRSOFT by CYBERGUN S.A.. Pictures are not contractual. Products shown in this catalog may vary slightly, according to productions and continents, as well as mentioned features (velocity, power range, etc).  
**FR:** Les marques déposées THOMPSON & AUTO ORDNANCE et leurs logos sont la propriété de Saello Enterprises, INC, et sont utilisés sous licence exclusive et mondiale pour l'AIRSOFT par CYBERGUN S.A.. Photos non contractuelles. Les produits montrés dans ce catalogue peuvent varier très légèrement en fonction des productions et des continents, tout comme leurs caractéristiques techniques (vitesse, portée utile, etc).  
**ES:** THOMPSON & AUTO ORDNANCE y sus logotipos son marcas registradas de Saello Enterprises, INC, y se utilizan bajo licencia mundial exclusiva para AIRSOFT por CYBERGUN S.A. Las imágenes no son contractuales. Los productos mostrados en este catálogo pueden variar ligeramente, según producciones y continentes, así como las características mencionadas (velocidad, alcance útil, etc.).



**EN:** VC'R and their logos are registered trademarks of Verney-Carron, and are used under exclusive worldwide license for AIRSOFT and AIRGUN by CYBERGUN S.A.. Pictures are not contractual. Products shown in this catalog may vary slightly, according to productions and continents, as well as mentioned features (velocity, power range, etc).  
**FR:** Les marques déposées VC'R et leurs logos sont la propriété de Verney-Carron, et sont utilisés sous licence exclusive et mondiale pour l'AIRSOFT et l'AIRGUN par CYBERGUN S.A.. Photos non contractuelles. Les produits montrés dans ce catalogue peuvent varier très légèrement en fonction des productions et des continents, tout comme leurs caractéristiques techniques (vitesse, portée utile, etc).  
**ES:** VC'R y sus logotipos son marcas registradas de Verney-Carron, y se utilizan bajo licencia mundial exclusiva para AIRSOFT y AIRGUN por CYBERGUN S.A. Las imágenes no son contractuales. Los productos mostrados en este catálogo pueden variar ligeramente, según producciones y continentes, así como las características mencionadas (velocidad, alcance útil, etc.).

# SAFETY RULES

## RÈGLES DE SÉCURITÉ – NORMAS DE SEGURIDAD

**EN:** A person who is at least 18 years old can buy a replica in most countries. Some of the replicas with the CE label can be sold to children 6 years or older, as their energy is less than 0.08 Joule. Please comply with the legislation in your country. Where can you buy these replicas? You can find them in gun shops, video game stores, toy stores, ... For more details : [infos@cybergun.com](mailto:infos@cybergun.com)

These replicas are intended for leisure shooting, on targets or in the open air, and require the wearing of EN 166 A/B standard protective goggles with an elastic strap. The sale of the replicas in this catalog is regulated in France by the decree of March 24, 1999. The replicas are absolutely harmless as long as some basic safety rules are respected (do not aim at a person or an animal or display these replicas in public places or transportation, ...). A notice is included in each package explaining the operation and safety rules concerning our replicas. The energy developed by these replicas is about 0.5 Joule, which is equivalent to the fall of a tennis ball from a height of one meter. For your information, the energy developed by lead pellet rifles at Fun Fairs is about 10 Joules, which is 20 times more powerful.

**FR:** Une personne âgé d'au moins 18 ans peut acheter une réplique dans la plupart des pays. Certaines des répliques avec l'étiquette CE peuvent être vendus aux enfants de 6 ans ou plus, comme leur énergie est inférieure à 0.08 Joule. Conformez-vous à la législation en vigueur de votre pays. Où pouvez-vous acheter ces répliques ? Vous pouvez les trouver chez les armuriers, les magasins de jeux-vidéos, les magasins de jouets, ... Pour plus de détails : [infos@cybergun.com](mailto:infos@cybergun.com)

Ces répliques sont destinées au tir de loisir, sur cibles ou en plein air, et requièrent le port de lunettes de protection normée EN 166 A/B avec élastique de maintien. La vente des répliques de ce catalogue est réglementée en France par le décret du 24 mars 1999. Les répliques sont absolument inoffensifs pour peu que l'on respecte quelques règles élémentaires de sécurité (ne pas viser une personne ou un animal ou exhiber ces répliques dans des lieux ou transports publics, ...). Une notice est incluse dans chaque emballage expliquant le fonctionnement et les règles de sécurité concernant nos répliques. L'énergie développée par ces répliques est d'environ 0.5 Joule, ce qui équivaut à la chute d'une balle de tennis d'un mètre de hauteur. Pour information, l'énergie développée par les carabines à plomb de fête foraine est d'environ 10 Joules, soit 20 fois plus puissante.

**ES:** Una persona de al menos 18 años puede comprar una réplica en la mayoría de los países. Algunas de las réplicas con la etiqueta CE pueden venderse a niños de 6 años o más, ya que su energía es inferior a 0.08 Julio. Siga la legislación de su país. ¿Dónde se pueden comprar estas réplicas? Se pueden encontrar en armerías, tiendas de videojuegos, jugueterías, ... Para más detalles: [infos@cybergun.com](mailto:infos@cybergun.com)

Estas réplicas están destinadas al tiro recreativo, en dianas o al aire libre, y requieren el uso de gafas de protección de la norma EN 166 A/B con soporte elástico. La venta de las réplicas de este catálogo está regulada en Francia por el decreto del 24 de marzo de 1999. Las réplicas son absolutamente inofensivas siempre que se respeten algunas normas elementales de seguridad (no apuntar a una persona o a un animal ni exhibir estas réplicas en lugares o transportes públicos, ...). En cada paquete se incluye un folleto que explica el funcionamiento y las normas de seguridad de nuestras réplicas. La energía desarrollada por estas réplicas es de unos 0.5 Julio, lo que equivale a la caída de una pelota de tenis desde una altura de un metro. A título informativo, la energía que desarrollan los rifles de balines de feria es de unos 10 Julios, lo que supone una potencia 20 veces superior.

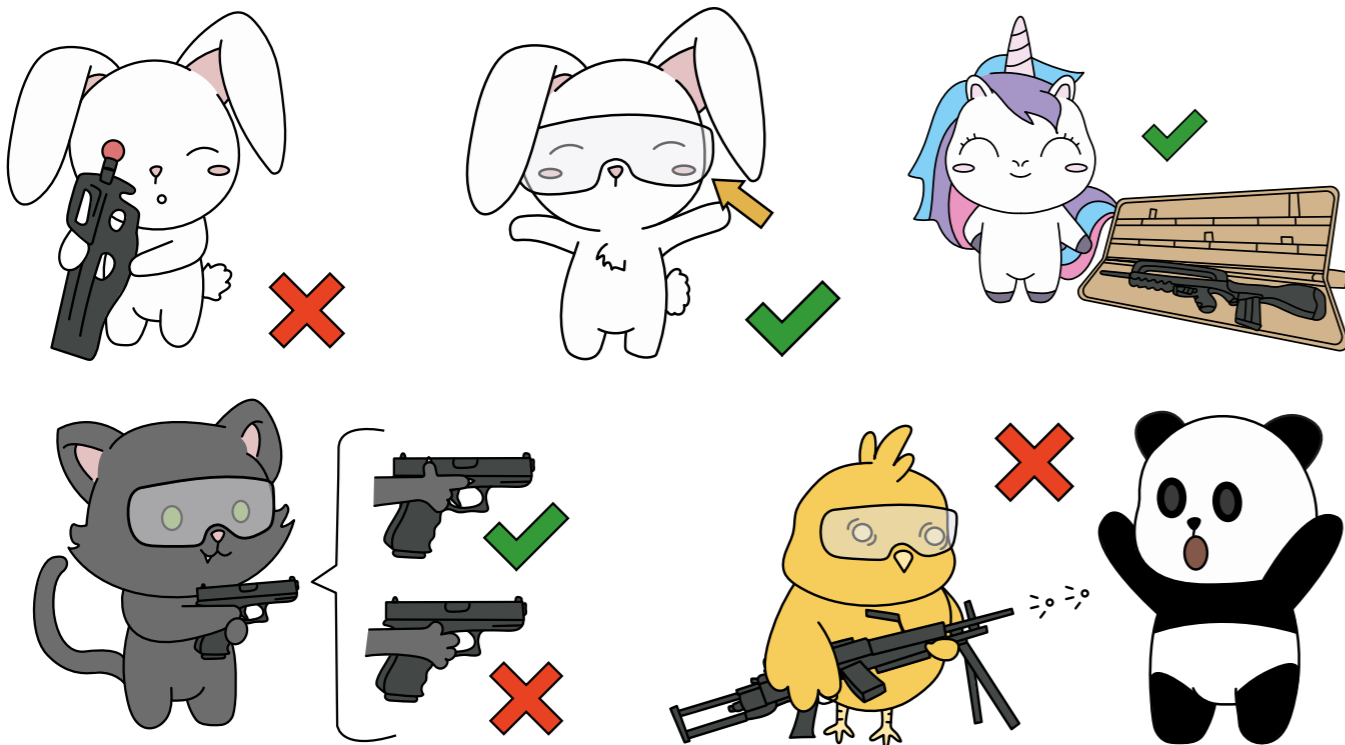

# TERMS OF SALES

## CONDITIONS DE VENTE – CONDICIONES DE VENTA

### 1. PURPOSE

The terms and conditions of sale below set out the rights and obligations of CYBERGUN SA ("CYBERGUN"), located at 40 boulevard Henri-Sellier, 92150 Suresnes (the "Head Office") and its client (the "Client") in the context of any purchase of goods or services offered by CYBERGUN, including but not limited to the sale of replicas, weapons accessories, consumables, and all products offered in the CYBERGUN catalogue available <http://www.cybergun.com/>.

Any sale by CYBERGUN is subject to the Client's unreserved acceptance of these terms and conditions of sale, which may be amended in accordance with the provisions of Article 15 below. CYBERGUN undertakes to make available to its Clients the latest applicable version of the terms and conditions of sale on its website at <https://cybergun.com/tos/?lang=en> and to send them by e-mail upon request.

If any provision of these terms and conditions of sale is deemed invalid, void, or unenforceable for any reason whatsoever, such provision shall be deemed severable and shall not affect the validity and enforceability of the remaining provisions.

### 2. REGULATION OF REPLICA WEAPONS

The distribution and marketing of replica weapons are subject to strict compliance with the applicable laws and regulations, and in particular the Decree 99-240 of March 24, 1999, which provides that:

- Article 1er: « The offer, offering for sale, sale, free distribution or making available for consideration or for new or used objects having the appearance of a firearm intended to launch rigid projectiles, when they develop mouth an energy greater than 0,08 Joule and up to 2 Joules are regulated under the conditions defined by this decree »
- Article 2: « Selling, distributing the products referred to in Article 1 of this Decree to minor children free of charge or making such products available to them for consideration or free of charge of shall be prohibited. »

The Client shall be held fully liable and solely responsible in the event that it fails to comply with the applicable laws and regulations referred to above. Under no circumstances shall CYBERGUN be liable in the event of the sale of a replica weapon to a minor child by the Client.

### 3. ACCOUNT OPENING

Any request to open an account must firstly be accepted by CYBERGUN and all information and supporting documents requested by CYBERGUN's sales department to that effect must be submitted, and more specifically:

- a valid and active e-mail address (the "E-Mail Address"), the Client undertaking to inform CYBERGUN should this E-Mail Address change,
- a corporate registration certificate issued within the last 3 months,
- bank account references,
- bank's contact information (address, telephone number and name of the account manager),
- an individual tax identification number, and these terms and conditions of sale dated, signed, initialed and stamped with the company seal.

### 4. ORDERS

Before placing an order, the Client agrees to read the latest version of the general terms and conditions of sale applicable on CYBERGUN's website at the following address <https://cybergun.com/tos/?lang=en>. Any order implies the unreserved acceptance of CYBERGUN's terms and conditions of sale in their latest updated version, on the day of the order.

Once the Client's order is received, CYBERGUN reserves the right to either accept or reject it or to issue reservations. An acknowledgement of receipt does not constitute acceptance of an order by CYBERGUN. The Client agrees to receive its invoices electronically.

### 5. PRICE

#### 5.1. PRICE OF GOODS:

The prices of the goods sold are those in force on the day the order is taken. They are denominated in euros and calculated net of tax. Consequently, they will be increased by the VAT rate.

#### 5.2. ADMINISTRATIVE FEES AND TRANSPORT COSTS:

In addition to the price of the goods, CYBERGUN will invoice the Client for each order placed:

- fifteen euros (15€) exclusive of taxes, for management fees, and
- the shipping costs applicable on the day of the order.

#### 5.3. PRICE CHANGES:

CYBERGUN may, during the course of the contract, revise its pricing conditions, either upwards or downwards, to take into account the general evolution of prices, the variation of euro/dollar rates, competition, and the production costs of the products and pass on these evolutions and variations in a fair and balanced manner, provided that the general economy of the contract is not called into question and that the Client can continue to face competition.

Notwithstanding the foregoing, CYBERGUN undertakes to invoice the goods ordered at the prices indicated at the time the order is registered.

#### 5.4. DISCOUNTS, REBATES AND OTHER PAYMENTS DEDUCTION:

The proposed prices include discounts, rebates, and other payment deductions that CYBERGUN may grant based on the scope of the Client's orders or the assumption of certain services by the Client.

#### 5.5. ERRORS IN PRICE:

Even if CYBERGUN accepts an order placed by the Client, in the event of a manifest price error, CYBERGUN shall be entitled, within thirty (30) days of accepting the order, to either invoice the Client for the actual price of the product on the date of the order, or, should the Client prefer, to cancel the order or, if the products have already been delivered, take them back at its own expense. Under no circumstances may the Client benefit from a price less than the sales profit/loss threshold.

#### 5.6. CUSTOMS:

Any customs clearance costs shall be paid by the Client. The Client further acknowledges that when it orders products from CYBERGUN for delivery outside the European Union, it is considered to be the official importer and as such must comply with all laws and regulations of the country in which it receives the products.

### 1. OBJET

Les conditions générales de vente décrites ci-après détaillent les droits et obligations de la société CYBERGUN SA (le « Vendeur » ou « CYBERGUN »), sis 40 boulevard Henri-Sellier, 92150 Suresnes (le « Siège »), et de son client (le « Client ») dans le cadre de tout achat de bien ou de service proposé par CYBERGUN, notamment mais sans s'y limiter la vente de répliques d'armes, accessoires et consommables, ainsi que tout produit commercialisé sur le catalogue CYBERGUN disponible sur son site internet à l'adresse <http://www.cybergun.com>.

Toute vente par CYBERGUN est conditionnée à l'adhésion sans réserve du Client aux présentes conditions générales de vente, lesquelles sont susceptibles d'être modifiées dans les conditions prévues en leur article 15. CYBERGUN s'engage à mettre à la disposition de ses Clients la dernière version applicable des conditions générales de vente sur son site internet à l'adresse <https://cybergun.com/conditions-generalesde-ventes/> et par courriel sur simple demande.

Si une stipulation des présentes conditions générales de vente est réputée non valide, nulle, ou inapplicable, quelle qu'en soit la raison, cette stipulation sera réputée divisible et n'affectera pas la validité et l'opposabilité des stipulations restantes.

### 2. DISPOSITIONS LEGALES ET REGLEMENTAIRES APPLICABLES AUX REPLIQUES D'ARMES

CYBERGUN rappelle que la distribution et la commercialisation des répliques sont soumises au strict respect des dispositions légales et réglementaires applicables, et en particulier à celles du Décret n°99-240 du 24 mars 1999 qui prévoit notamment que :

- Article 1er : « L'offre, la mise en vente, la vente, la distribution à titre gratuit ou la mise à disposition à titre onéreux ou gratuit des objets neufs ou d'occasion ayant l'apparence d'une arme à feu, destinés à lancer des projectiles rigides, lorsqu'ils développent à la bouche une énergie supérieure à 0,08 joule et inférieure ou égale à 2 Joules, sont réglementées dans les conditions définies par le présent décret »
- Article 2 : « La vente, la distribution à titre gratuit à des mineurs ou la mise à leur disposition à titre onéreux ou gratuit des produits visés à l'article 1er du présent décret sont interdites »

Le non-respect de ces dispositions par le Client engage son entière responsabilité et unique responsabilité. En aucun cas, la responsabilité de CYBERGUN ne saurait être engagée en cas de vente d'une réplique à un mineur par le Client.

### 3. OUVERTURE DE COMPTE

Toute ouverture de compte est soumise à l'acceptation préalable de CYBERGUN, ainsi qu'à la communication de l'ensemble des informations et pièces justificatives demandées par le service commercial de CYBERGUN, et plus particulièrement :

- une adresse courriel valide et active (l'« Adresse E-Mail »), le Client s'engageant à informer le Vendeur de tout changement de cette Adresse E-Mail,
- un extrait K-Bis de moins de trois 3 mois,
- un Relevé d'Identité Bancaire,
- les coordonnées bancaires du Client (adresse, téléphone et nom du gestionnaire de compte),
- un numéro d'identification fiscal individuel, et les présentes conditions générales de vente datées, signées, paraphées et revêtues du cachet commercial.

### 4. COMMANDES

Avant toute commande, le Client s'engage à prendre connaissance de la dernière version des conditions générales de vente applicables sur le site internet de CYBERGUN à l'adresse <https://cybergun.com/conditions-generales-de-ventes/>. Toute commande implique l'acceptation sans réserve des conditions générales de vente de CYBERGUN dans leur dernière version mise à jour, au jour de la commande.

CYBERGUN se réserve le droit, à compter de la réception de la commande du Client, de l'accepter, de la rejeter ou de faire des réserves. Un accusé de réception ne constitue pas une acceptation de commande par CYBERGUN. Le Client accepte de recevoir ses factures par voie électronique.

### 5. PRIX

#### 5.1. PRIX DES MARCHANDISES :

Les prix des marchandises vendues sont ceux en vigueur au jour de la prise de commande. Ils sont libellés en euros et calculés hors taxes. Par voie de conséquence, ils seront majorés du taux de TVA.

#### 5.2. FRAIS DE GESTION ET FRAIS DE TRANSPORT :

En sus du prix des marchandises, CYBERGUN facturera au Client pour chaque commande passée :

- quinze euros (15€) hors taxes, de frais de gestion, et
- les frais de transport applicables au jour de la commande.

#### 5.3. VARIATIONS DE PRIX :

CYBERGUN pourra, en cours de contrat, réviser ses conditions tarifaires, à la hausse ou à la baisse, pour tenir compte de l'évolution générale des prix, de la variation des cours euro/dollar, de la concurrence et des coûts de production des produits, et répercuter de façon équitable et équilibrée ces évolutions et variations, pour autant que l'économie générale de la convention ne soit pas remise en cause et que le Client puisse continuer à faire face à la concurrence. Toutefois, CYBERGUN s'engage à facturer les marchandises commandées aux prix indiqués lors de l'enregistrement de la commande.

#### 5.4. RABAIS, REMISES ET RISTOURNES :

Les prix proposés comprennent les rabais, remises et autres déductions de paiement que CYBERGUN peut accorder en fonction de la nature des commandes du Client ou de la prise en charge de certains services par le Client.

#### 5.5. ERREURS DE PRIX :

Nonobstant l'acceptation par CYBERGUN d'une commande de la part du Client, en cas d'erreur manifeste de prix, CYBERGUN est en droit, dans un délai de trente (30) jours à compter de l'acceptation de la commande de facturer le Client pour le prix réel du produit à la date de la commande ou, si le Client le préfère, annuler la commande ou, si les produits ont déjà été livrés, les reprendre à ses frais. En aucun cas, le Client ne saurait se prévaloir d'un prix inférieur au seuil de revente à perte.

#### 5.6. DOUANES :

Tous les frais de dédouanement seront à la charge du Client. Le Client reconnaît par ailleurs que lorsqu'il commande des produits chez CYBERGUN pour être livré en dehors de l'Union Européenne, il est considéré comme l'importateur officiel et doit à ce titre respecter toutes les lois et règlements du pays dans lequel il reçoit les produits.



## 6. RETENTION OF TITLE

CYBERGUN shall retain title of the delivered goods as from the day on which they are delivered until full payment of the total sale price. Notwithstanding the foregoing, risk shall be transferred to the recipient as from the time the goods are made available. Delivery of a bill of exchange or any other instrument creating an obligation to pay does not constitute payment.

In the event of non-payment, CYBERGUN shall be entitled to take back the goods or have them taken back at the Client's expense. CYBERGUN may similarly claim the return of the goods and/or the payment of the price thereof from any subsequent purchasers. This clause constitutes an integral part of the terms and conditions of sale and the Client represents that it accepts it without reservation.

## 7. TERMS OF PAYMENT AND DISCOUNT

Payment of orders is made either by cheque, or by credit card, or by bank transfer. Where applicable, the other accepted means of payment are indicated on the invoice. No discount will be granted for early payment.

## 8. LATE PAYMENT

In the event that the delivered goods have not been paid in whole or part on the day of receipt, the Client must pay CYBERGUN a late payment penalty equal to the interest rate applied by the European Central Bank to its most recent refinancing operation, increased by ten (10) percentage points in accordance with the provisions of Article L.441-10 of the French Commercial Code. This penalty shall be calculated based on the amount inclusive of taxes of the outstanding sum and shall be applied from the date the price is due without any prior formal notice being necessary.

In addition to the compensation for late payment, any amount (including the deposit) not paid on its due date shall automatically give rise to the payment of lump-sum compensation in an amount of forty euros (40€) for recovery costs in accordance with the provisions of Article D. 441-5 of the French Commercial Code (Code du commerce). In the event that the collection costs are higher than this amount, the Client will be required to compensate CYBERGUN for the loss suffered up to the amount of the supporting documents produced.

## 9. TERMINATION CLAUSE

If the Client has not paid the outstanding amounts within fifteen days following the sending of a notification on the E-Mail Address of the implementation of the article 8. Late payment, the sale shall be automatically cancelled and CYBERGUN shall be entitled to claim damages as a result. CYBERGUN shall be entitled to terminate all contracts entered into with the Client as a result of the latter's failure to fulfil its essential obligation to pay the price of the goods sold by CYBERGUN.

## 10. DELIVERY

Delivery is made either by direct delivery of the goods or by shipment to the location indicated by the Client on the order form. The costs of carriage and insurance shall be borne by the Client. Free shipping is applied to all orders over one thousand euros (1,000 €) excluding taxes, on the territory of Metropolitan France only. Upon the Client's express request, CYBERGUN may take the necessary step to subscribe to an insurance policy covering the transportation of the goods. The Client shall bear any corresponding insurance costs. Consequently, the Client waives any recourse against CYBERGUN in the event of loss, disappearance, or, in a general manner, for any damage suffered during transport. Delivery times are indicative. The Client, in the event of exceeding the delivery deadlines, expressly waives any discount, damages, or cancellation of orders in progress.

In the event of missing or damaged goods during transport, the Client must formulate all precise and justified reserves on the delivery order upon receipt of said goods, indicating the missing and/or damaged references. In the case of damaged goods, the Client must describe precisely the damage on the delivery order. These reserves must also be confirmed in writing within three (3) working days of delivery, by letter with acknowledgment of receipt addressed to the carrier. The Client agrees to simultaneously communicate to CYBERGUN Head Office a copy of the said letter of reserves. Any return of material must be subject to CYBERGUN's prior agreement.

By signing the delivery order without making any reserves, the Client accepts the goods and waives any claim against CYBERGUN. For information purposes, the Client has the right, in case of doubt, to check the contents of the package containing the goods in the presence of the carrier, before signing the delivery order, as the carrier cannot oppose it.

## 11. INTELLECTUAL PROPERTY

The Client expressly represents that it has not committed any act of infringement or concealment of infringement of the intellectual property rights associated with the products sold by CYBERGUN (in particular copyright, design rights, trademark rights) of the owner of said rights, and undertakes not to commit any such act of infringement or concealment of infringement in any way whatsoever, including at the expiry of the sales contract. Failure to comply with this clause shall result in the automatic termination of the contract and the Client shall be liable to criminal and civil proceedings, including the payment of damages to the CYBERGUN and/or the owner of the intellectual property rights.

## 12. WARRANTIES

CYBERGUN remains bound by the warranties provided by law. Subject to normal use of the goods, CYBERGUN warrants the Client against (i) any lack of conformity, for one year as from delivery of the goods, and (ii) any hidden defect under the conditions provided for in Articles 1641 et seq. of the French Civil Code (Code civil). No warranty shall be applicable in the event of misuse, negligence or fault on the part of the Client.

## 13. MAJOR FORCE

Neither party shall be liable as a result of any delay or failure to perform its obligations under these terms and conditions of sales if and to the extent that such delay or failure is caused by a Force Majeure event, as defined per article 1218 of the Civil code. Furthermore, the parties expressly agree to consider that the following events shall constitute Force Majeure events:

- occurrence of a natural disaster
- earthquake, storm, fire, flood, etc.
- armed conflict, war, conflict, attacks
- labor dispute, total or partial strike at CYBERGUN or the Client
- labor dispute, total or partial strike at subcontractors, service providers, transporters, postal services, public services, etc.
- imperative injunction of the public authorities (import ban, embargo)
- operating accidents, machinery breakdown, explosion
- any pandemic recognized by the World Health Organization or any state of health emergency declared by the state authorities of a territory in which the Parties and/or their subcontractors operate.

The party who invokes the Force Majeure shall take all reasonable measures to limit the adverse consequences of the Force Majeure event for the other party.

In case of temporary impediment, the performance of the obligations which is impossible due to the Force Majeure event shall be suspended for the duration of such Force Majeure event. If the Force Majeure event lasts more than sixty (60) days, either party may terminate the contract by providing a thirty (30) day prior written notice to the other party.

In case of permanent impediment, the contract shall be automatically terminated and the parties free from their obligations.

## 6. RESERVE DE PROPRIETE

CYBERGUN reste propriétaire de la marchandise livrée à compter du jour de livraison jusqu'à complet paiement de l'intégralité du prix de vente, les risques de la marchandise incombant néanmoins au destinataire, dès la mise à disposition de celle-ci. Ne constituent pas des paiements, les remises de traites ou de tous titres créant une obligation de payer.

En cas de non-paiement, CYBERGUN est en droit d'effectuer ou de faire effectuer la reprise de la marchandise à la charge du Client. De même, CYBERGUN pourra revendiquer entre les mains des sous-acquéreurs la restitution des marchandises, et/ou le paiement de leurs prix. Cette clause fait partie intégrante des conditions générales de vente, et le Client déclare l'accepter sans réserve.

## 7. MODALITES DE PAIEMENT ET ESCOMPTE

Le règlement des commandes s'effectue par chèque, par carte bancaire ou par virement bancaire. Le cas échéant, les autres moyens de paiement acceptés sont indiqués sur la facture. Aucun escompte ne sera consenti en cas de paiement anticipé.

## 8. RETARD DE PAIEMENT

En cas de défaut de paiement total ou partiel des marchandises livrées au jour de la réception, le Client doit verser à CYBERGUN une pénalité de retard égale au taux d'intérêt appliqué par la Banque Centrale Européenne à son opération de refinancement la plus récente, majorée de dix (10) points de pourcentage conformément aux dispositions de l'article L.441-10 du Code de commerce. Cette pénalité est calculée sur le montant TTC de la somme restant due, et court à compter de la date d'échéance du prix sans qu'aucune mise en demeure préalable ne soit nécessaire.

En sus des indemnités de retard, toute somme, y compris l'acompte, non payée à sa date d'exigibilité produira de plein droit le paiement d'une indemnité forfaitaire de quarante (40€) euros due au titre des frais de recouvrement conformément aux dispositions de l'article D. 441-5 du code de commerce. Néanmoins, si les frais de recouvrement finalement engagés par CYBERGUN sont supérieurs à l'indemnité forfaitaire susmentionnée, CYBERGUN pourra, sur présentation des justificatifs des montants engagés, demander une indemnisation complémentaire au Client dans les conditions prévues par la loi n°2012-387 du 22 mars 2012.

## 9. CLAUSE RESOLUTOIRE

Si le Client ne s'est pas acquitté des sommes restantes dues dans les quinze jours qui suivent l'envoi d'une notification écrite à l'Adresse E-Mail de la mise en œuvre de la clause 8. Retard de paiement susmentionnée, la vente sera résolue de plein droit et pourra ouvrir droit à l'allocation de dommages et intérêts au profit de CYBERGUN. CYBERGUN pourra dénoncer tous accords conclus avec le Client du fait de l'inexécution par ce dernier de son obligation essentielle de payer le prix des marchandises vendues par CYBERGUN.

## 10. LIVRAISON

La livraison est effectuée soit par la remise directe de la marchandise, soit par expédition au lieu indiqué par le Client sur le bon de commande. Les frais et risques de transport sont à la charge du Client. Un franco de port est appliqué à toutes commandes supérieures à mille euros (1,000€) hors taxes, sur le territoire de la France Métropolitaine uniquement. CYBERGUN pourra, sur demande expresse du Client et aux frais de ce dernier, souscrire une assurance pour le transport des marchandises. En conséquence, le Client renonce à tout recours contre CYBERGUN en cas de perte, de disparition ou, d'une manière générale, pour tout dommage subi durant le transport. Les délais de livraison sont indicatifs. Le Client, en cas de dépassement des délais de livraison, renonce expressément à toute remise, dommages et intérêts, ou annulation des commandes en cours.

En cas de marchandises manquantes ou détériorées lors du transport, le Client devra formuler toutes réserves précises et motivées sur le titre de transport à réception desdites marchandises, en indiquant les références manquantes et/ou endommagées. Dans le cas de marchandises endommagées, le Client devra décrire précisément les dommages sur le titre de transport. Ces réserves devront être, en outre, confirmées par écrit dans les trois (3) jours ouvrables suivant la livraison, par lettre recommandée avec accusé de réception adressé au transporteur. Le Client s'engage à communiquer simultanément à CYBERGUN la copie de ladite lettre de réserves par lettre recommandée avec accusé de réception adressée au Siège de CYBERGUN. Tout retour de matériel doit faire l'objet d'un accord préalable de CYBERGUN.

En signant le bon de livraison sans émettre de réserves, le Client accepte la marchandise et renonce à toute réclamation à l'encontre de CYBERGUN. A titre d'information, le Client dispose en cas de doute du droit de vérifier le contenu du colis contenant les marchandises en présence du transporteur, avant de signer le bon de livraison, le transporteur ne pouvant s'y opposer.

## 11. PROPRIETE INTELLECTUELLE

Le Client déclare expressément n'avoir jamais commis d'acte ou de recel de contrefaçon des droits de propriété intellectuelle associés aux produits vendus par CYBERGUN (et notamment des droits d'auteur, droit des dessins et modèles, droit des marques), et s'engage à ne pas en commettre d'une quelconque manière que ce soit, y compris à l'expiration du contrat de vente. Le non-respect de cette clause emportera la résiliation, de plein droit, du contrat et le Client s'exposera à des poursuites pénales et civiles dont le versement de dommages intérêts au vendeur et/ou au titulaire des droits de propriété intellectuelle.

## 12. GARANTIES

CYBERGUN reste tenue des garanties prévues par la loi. Sous réserve d'un usage normal de la marchandise, CYBERGUN garantit le Client contre (i) tout défaut de conformité pendant une période d'un an à compter de la délivrance des marchandises, et (ii) tout vice caché dans les conditions prévues aux articles 1641 et suivants du code civil. Aucune garantie ne pourra être appliquée en cas de mauvaise utilisation, négligence ou faute du Client.

## 13. FORCE MAJEURE

Aucune des parties ne pourra être tenue pour responsable de son retard ou de sa défaillance à exécuter l'une des obligations à sa charge, au titre des présentes conditions générales de vente si ce retard ou cette défaillance sont l'effet direct ou indirect d'un cas de Force Majeur au sens de l'article 1218 du Code civil. En outre, les parties conviennent expressément de considérer que les événements suivants constituent des cas de Force Majeure :

- survenance d'un cataclysme naturel
- tremblement de terre, tempête, incendie, inondation etc.
- conflit armé, guerre, conflit, attentats
- conflit du travail, grève totale ou partielle chez CYBERGUN ou le Client
- conflit du travail, grève totale ou partielle chez les sous-traitants, prestataires de services, transporteurs, postes, services publics, etc.
- injonction impérative des pouvoirs publics (interdiction d'importer, embargo)
- accidents d'exploitation, bris de machines, explosion
- toute pandémie reconnue par l'Organisation mondiale de la santé ou tout état d'urgence sanitaire
- déclaré par les autorités étatiques d'un territoire sur lequel les Parties et/ou leurs sous-traitants opèrent.

La partie qui invoque la Force Majeure doit prendre toutes les mesures raisonnables pour limiter les conséquences négatives de l'événement de Force Majeure pour l'autre partie.

En cas d'empêchement temporaire, l'exécution des obligations rendue impossible par l'événement de Force Majeure sera suspendue pendant la durée de cet événement de Force Majeure. Si l'événement de Force Majeure dure plus de soixante (60) jours, chaque partie peut résilier le contrat en adressant à l'autre partie un préavis écrit de trente (30) jours.

En cas d'empêchement définitif, le contrat sera automatiquement résilié et les parties seront libérées de leurs obligations.

## 14. CLAIM

The Client shall not return any goods without CYBERGUN's prior written agreement. Any claim by the Client must be made by registered letter to CYBERGUN Head Office with acknowledgment of receipt within three (3) working days of delivery of the goods. Failing this, complaints (excluding hidden defects) are not opposable to CYBERGUN.

In the event, CYBERGUN accepts the claim, the goods shall be returned to CYBERGUN in their original packaging accompanied by the invoice and the delivery order. If necessary, the Client undertakes to pay the return transport costs.

If the manufacturer of the product has ceased to market the parts and/or components of the returned goods, CYBERGUN will not be subject to any delay in repairing the product or obtaining said parts and components.

If necessary, CYBERGUN may offer the Client a new product, which must be the subject of a new order form.

## 15. MODIFICATIONS OF THE TERMS AND CONDITIONS OF SALES

CYBERGUN reserves the right to modify the terms of the present terms and conditions of sale at any time in the form of an e-mail sent to the E-Mail Address provided by the Client when opening an account. It is specified that the Client is solely responsible for keeping the E-Mail Address active and for consulting the messages sent to it by CYBERGUN. In case of disagreement, the Client retains the right to terminate the contract within 30 days of notification of the changes. Any notification must be sent to CYBERGUN by letter with acknowledgment of receipt to CYBERGUN Head Office. In the absence of a response or in case of a new order from the Client within the aforementioned period of thirty (30) days following the sending of the new general sales conditions, the Client's acceptance of the new terms and conditions of sales is deemed tacit.

## 16. GOVERNING LAW - COMPETENT COURTS

Any dispute relating to the validity, construction and enforcement of these terms and conditions of sale is subject to French law. Failing an amicable settlement, the dispute will fall under the exclusive jurisdiction of the commercial court of Nanterre (92).

## 14. RECLAMATION

Aucun retour de produit ne peut être effectué unilatéralement par le Client sans l'accord préalable et écrit communiqué par CYBERGUN. Les réclamations doivent être formulées par le Client par lettre recommandée avec accusé de réception adressée au Siège de CYBERGUN dans un délai de trois (3) jours ouvrés à compter de la livraison des marchandises. A défaut, les réclamations (hors vice caché) ne sont pas opposables à CYBERGUN.

En cas d'acceptation de la réclamation par CYBERGUN, les produits seront retournés à CYBERGUN dans leur emballage d'origine accompagnés de la facture et du bordereau de livraison. Le cas échéant, le Client s'engage à prendre en charge les frais de transport de retour.

Dans l'hypothèse où le fabricant du produit concerné par le retour aurait cessé de commercialiser les pièces et/ou composants dudit produit, CYBERGUN ne sera pas soumis à un quelconque délai concernant l'éventuelle réparation du produit ou l'obtention desdites pièces et composants. Le cas échéant, CYBERGUN pourra proposer au Client un nouveau produit, devant faire l'objet d'un nouveau bon de commande.

## 15. MODIFICATION DES CONDITIONS GENERALES

CYBERGUN se réserve le droit de modifier les termes des présentes conditions générales de vente à tout moment sous la forme d'un courriel envoyé à l'Adresse E-Mail renseignée par le Client lors de son ouverture de compte. Le Client est seul responsable de maintenir l'Adresse E-Mail active et de consulter les messages qui y sont adressés par CYBERGUN. En cas de désaccord avec les nouvelles conditions générales de vente, le Client conserve la faculté de résilier le contrat sous trente (30) jours. Toute notification à CYBERGUN doit être écrite et lui être adressée par lettre recommandée avec accusé de réception au Siège. En l'absence de réponse ou en cas de nouvelle commande du Client dans la période susmentionnée de trente (30) jours suivant l'envoi des nouvelles conditions générales de vente, l'acceptation des nouvelles conditions générales de vente par le Client est réputée tacite.

## 16. DROIT APPLICABLE - TRIBUNAUX COMPETENT

Tout litige relatif à la validité, l'interprétation et à l'exécution des présentes conditions générales de vente est soumis au droit français. À défaut de résolution amiable, le litige relèvera de la compétence exclusive du Tribunal de Commerce de Nanterre (92).



# VC'R

**Find the VC'R range in  
our dedicated catalog.**

Retrouvez la gamme VC'R dans notre catalogue dédié.

— AIRSOFT & AIRGUN —



[www.verney-carron.com](http://www.verney-carron.com)



**CYBERGUN GROUP**

40 boulevard Henri Sellier  
92150 Suresnes, France  
Tel : +33 1 42 04 81 00  
infos@cybergun.com  
www.cybergun.com

**CYBERGUN HONK KONG**

Unit 22, 1F, office Building Block 2  
96 Sienna Avenue,  
Discovery Bay  
Lantau Island, NT  
Hong Kong

**CYBERGUN USA**

USA, Palco & Sausa DC  
+1817-717-4300  
4265 Trade Center, Grapevine,  
TX 76051  
USA

**CYBERGUN DENMARK**

Mobile : +45 3119 5644  
Haslegaardsvej 8-10,  
8210 Aarhus V

**CYBERGUN ITALY**

Via Chiaravalle,  
7, 20122 Milano  
VA, Italy

REF. ITEM: 191996



© Copyright Janvier 2024 - CYBERGUN